



**Thermon**  
South Africa (Pty) Ltd.

## Temperature Sensors

for the plastic and packaging industry



Thermon SA's range of temperature sensors includes numerous designs found on well-known brands of machines throughout the world. The construction and materials have been carefully matched to satisfy the requirements of the plastics and packaging industry.

The manufacturing system is tailored for quick delivery time and flexibility. Recognising the cost of downtime of machines, we offer a "SOS" service, manufacturing and dispatching replacements within a few hours after receipt of the order.



### For selection and ordering

Drawings and product codes of frequently used temperature sensors have been compiled on the following pages for ease of selection and ordering. In addition, we offer mineral insulated thermocouples in diameters down to 0.5mm and Pt 100 sensors down to 1.6mm.

Ordering: Please indicate the appropriate stock code when ordering. Sensors are supplied with a label attached to the cable, stating the part number, batch reference and sensor code.

We manufacture all types of temperature sensors to customers specifications. Please contact us with your requirements if none of the standard sensors fit your application.

### Technical Specifications

**Operating temperature limit at the tip of sensor:**

with PVC insulated cable inside:	-40°C +100°C
with teflon insulated cable inside:	-250°C +250°C
with glass fibre insulated cable inside:	-40°C +350°C
mineral insulation sheath:	up to 1100°C (can be higher using special alloys)

**Insulation** (between sensor cable and sensor stem):

Thermocouples are normally non-insulated ("grounded") unless otherwise specified

**Cable:**

The sensor cables are glass fibre insulated with steel overbraid, unless otherwise specified



## Barrel adapter

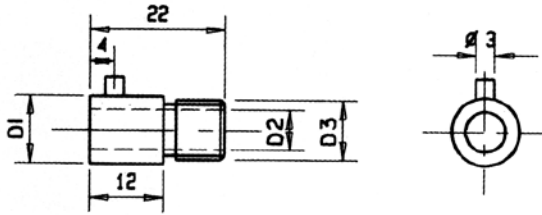

Stock code	D1 (mm)	D2 (mm)	D3 (mm)	Thread	Material
RSK-BGY0311A-00	11	6.5	1/8	BSP	Nickel PL. ST

## Barrel adapter

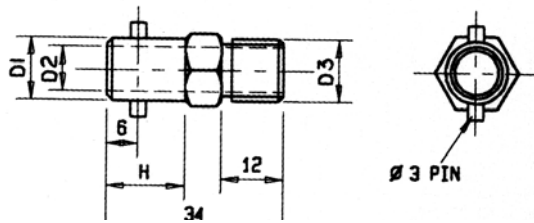

Stock code	D1 (mm)	D2 (mm)	D3 (mm)	Thread	H (mm)	Material
RSK-BGY0312A-00	12	8.5	M12x1.5	Metric	14	Nickel PL. ST
RSK-BGY0312B-00	12	8.5	M12x1	Metric	14	Nickel PL. ST
RSK-BGY0312C-00	12	8.5	1/4"	BSP	14	Nickel PL. ST
RSK-BGY0312D-00	12	8.5	3/8"	BSP	17	Nickel PL. ST
RSK-BGY0313A-00	13	8.5	M12x1.5	Metric	14	Nickel PL. ST
RSK-BGY0313B-00	13	8.5	M12x1	Metric	14	Nickel PL. ST
RSK-BGY0313C-00	13	8.5	1/4"	BSP	14	Nickel PL. ST
RSK-BGY0313D-00	13	8.5	3/8"	BSP	17	Nickel PL. ST

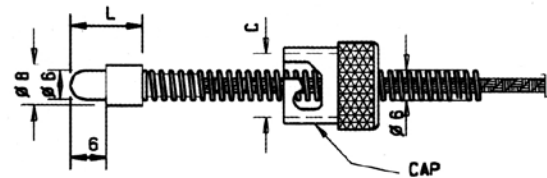

Stock code	D (mm)	L (mm)	Cable Length	C (mm)	Type
USTP2S-JY0855C3	6	12	1500mm	13.3	"J"-grounded
USTP2S-JY0855F3	6	12	3000mm	13.3	"J"-grounded

## Kawaguchi - Thermocouple

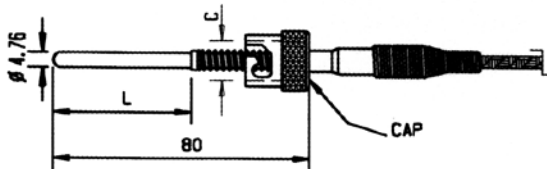

Stock code	D (mm)	L (mm)	Cable Length	C (mm)	Type
USTA2SX-KY0856A	4.76	43	3000mm	11.3	"K"-grounded

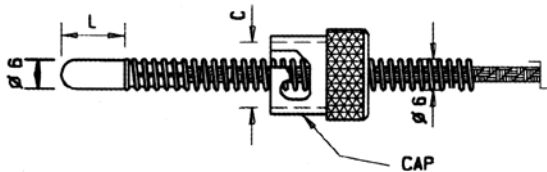

Stock code	D (mm)	L (mm)	Cable Length	C (mm)	Type
USTP2S-JY0854C2	6	18	1500mm	12.3	"J"-grounded
USTP2S-JY0854C3	6	18	1500mm	13.3	"J"-grounded
USTP2S-JY0854C5	6	18	1500mm	15.3	"J"-grounded
USTP2S-JY0854D3	6	18	2000mm	13.3	"J"-grounded
USTP2S-JY0854F3	6	18	3000mm	13.3	"J"-grounded
USTP2S-JY0854F5	6	18	3000mm	15.3	"J"-grounded

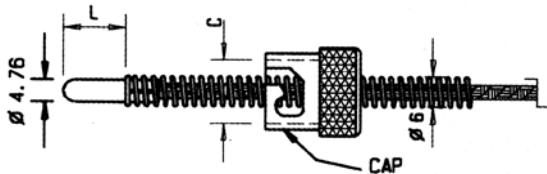

Stock code	D (mm)	L (mm)	Cable Length	C (mm)	Type
USTP2S-JY0853C1	4.76	18	1500mm	11.3	"J"-grounded
USTP2S-JY0853C2	4.76	18	1500mm	12.3	"J"-grounded
USTP2S-JY0853C3	4.76	18	1500mm	13.3	"J"-grounded
USTP2S-JY0853D3	4.76	18	2000mm	13.3	"J"-grounded
USTP2S-JY0853F3	4.76	18	3000mm	13.3	"J"-grounded



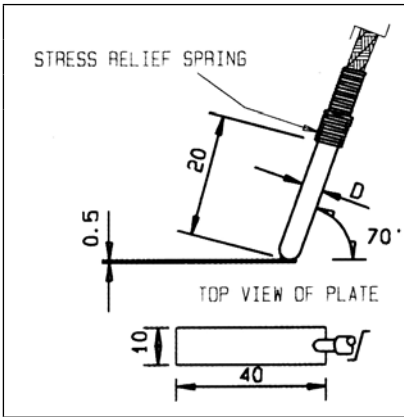

Stock code	D (mm)	Plate Size	Cable Length	Type
USFRXS-JY1010A0	3.5	40x10	1500mm	"J"-grounded
USFRXS-KY1011A0	3.5	40x10	1500mm	"K"-grounded

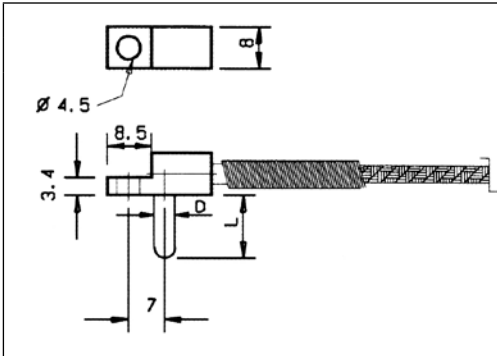

Stock code	D (mm)	Plate Size	Cable Length	Type
USXR1S-JY0653BO	4	12	1500mm	"J"-ungrounded

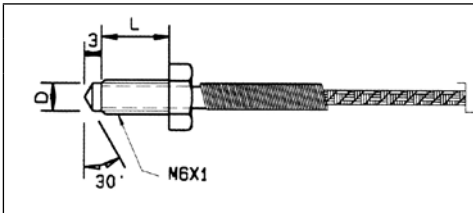

Stock code	D (mm)	Plate Size	Cable Length	Type
USWRBS-JY0825A0	4.8	12	1500mm	"J"-grounded

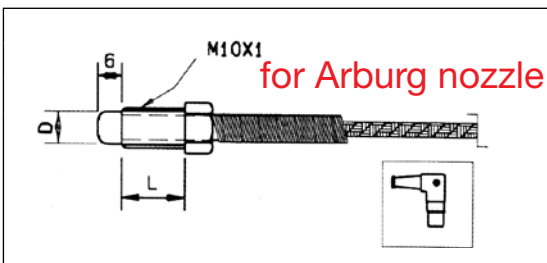

Stock code	D (mm)	Plate Size	Cable Length	Type
USWRDS-JY0827CO (with plug)	8	6	1500mm	"J"-grounded
USWRDS-JY0827AO (without plug)	8	6	1500mm	"J"-grounded

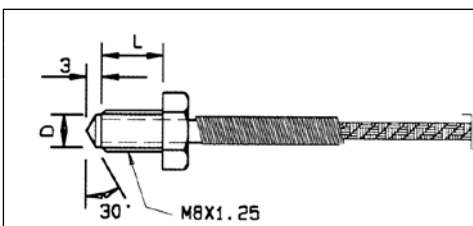

Stock code	D (mm)	Plate Size	Cable Length	Type
USWRCS-KY0823AO	6.3	12	3000mm	"K"-grounded
USWRCS-JY0826AO	6.3	12	1500mm	"J"-grounded

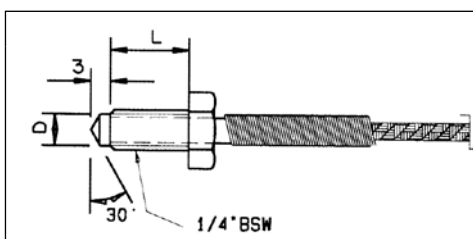

Stock code	D (mm)	Plate Size	Cable Length	Type
USWRXS-JY0824AO	4.8	12	1500mm	"J"-grounded

## Melt Temperature

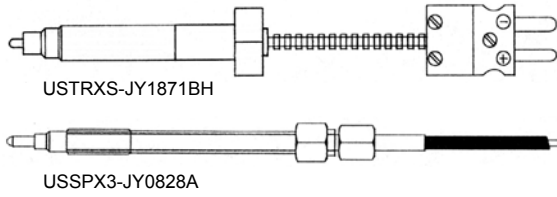

Stock code	Thread	Head Detail	Type
USSPX3-JY0430A	1/2" UNF	No Hex, Flexible with Plug	"J"-grounded
USSPX3-JY0430B	1/2" UNF	Hex Head, Flexible with Plug	"J"-grounded
USSPX3-JY0430C	1/2" UNF	Hex Head, Ridged with Plug	"J"-grounded
USTRXS-JY1871BH	1/2" UNF	Swivel tip with Hex Head	"J"-grounded

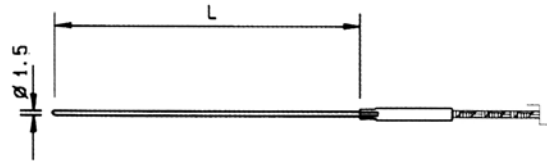

Stock code	D (mm)	L (mm)	Cable Length	Type
USTA1S-JY0152C2	1.5	100	1500mm	"J"-grounded

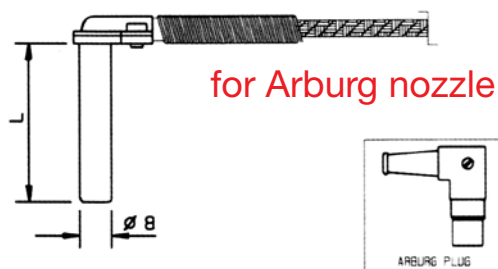

for Arburg nozzle

Stock code	D (mm)	L (mm)	Cable Length	Type
USERIS-JY0355AO	8	40	1200mm	"J"-grounded
USERIS-JY0355BO (with plug)	8	40	1200mm	"J"-grounded

## for Kawaguchi

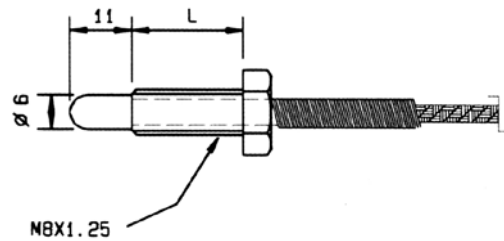

Stock code	D (mm)	L (mm)	Cable Length	Type
USWRCS-KY0935DO	6	20	2 000mm	"K"-grounded

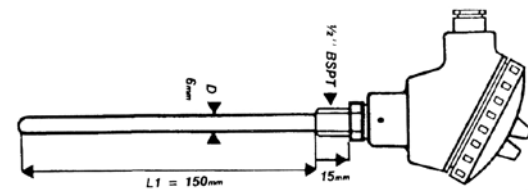

Stock code	D (mm)	L (mm)	Type
USTL8L-PY1419F	6	150	Pt 100
USTL8L-JY1422F	6	150	"J"-grounded
USTL8L-KY1426F	6	150	"K"-grounded