



USER'S MANUAL

SOFTWARE VERSION 4.0x
code 80336L / Edition 15 - 07/2011

1 • INSTALLATION

• Dimensions and cut-out; panel mounting

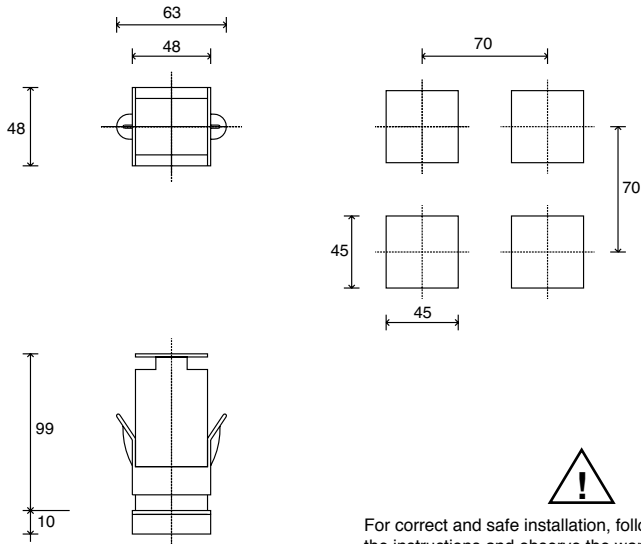

For correct and safe installation, follow the instructions and observe the warnings contained in this manual.

Panel mounting:

To fix the unit, insert the brackets provided into the seats on either side of the case.
To mount two or more units side by side, respect the cut-out dimensions shown in the drawing.

CE MARKING: The instrument conforms to the European Directives 2004/108/CE and 2006/95/CE with reference to the generic standards: **EN 61000-6-2** (immunity in industrial environment) **EN 61000-6-3** (emission in residential environment) **EN 61010-1** (safety).

MAINTENANCE: Repairs must be done only by trained and specialized personnel.

Cut power to the device before accessing internal parts.

Do not clean the case with hydrocarbon-based solvents (Petrol, Trichlorethylene, etc.). Use of these solvents can reduce the mechanical reliability of the device. Use a cloth dampened in ethyl alcohol or water to clean the external plastic case.

SERVICE: GEF 600 has a service department. The warranty excludes defects caused by any use not conforming to these instructions.

EMC conformity has been tested with the following connections

FUNCTION	CABLE TYPE	LENGTH
Power supply cable	1 mm ²	1 m
Relay output cable	1 mm ²	3,5 m
Digital communication wire	0,35 mm ²	3,5 m
C.T. connection cable	1,5 mm ²	3,5 m
TC input	0,8 mm ² compensated	5 m
Pt100 input	1 mm ²	3 m

2 • TECHNICAL SPECIFICATIONS

Display	2x4 digit green, high display 10 and 7mm
Keys	4 of mechanical type (Man/Aut, INC, DEC, F)
Accuracy	0.2% f.s. ±1 digit ambient temperature 25°C
Main input (settable digital filter)	TC, RTD, PTC, NTC 60mV.1V Ri≥1MΩ; 5V,10V Ri≥10KΩ; 20mA Ri=50Ω Tempo di campionamento 120 msec.
Type TC Thermocouples (ITS90)	Type TC Thermocouples : J,K,R,S,T (IEC 584-1, CEI EN 60584-1, 60584-2) ; custom linearization is available / types B,E,N,L GOST,U,G,D,C are available by using the custom linearization.
Cold junction error	0,1° / °C
RTD type (scale configurable within indicated range, with or without decimal point) (ITS90)	DIN 43760 (Pt100), JPT100
Max line resistance for RTD	20Ω
PTC type / NTC Type	990Ω, 25°C / 1KΩ, 25°C
Safety	detection of short-circuit or opening of probes, LBA alarm, HB alarm
°C / °F selection	configurable from faceplate
Linear scale ranges	-1999 to 9999 with configurable decimal point position
Controls	PID, Self-tuning, on-off
pb - dt - it	0,0...999,9 % - 0,00...99,99 min - 0,00...99,99 min
Action	Heat / Cool
Control outputs	on / off, continuous
Maximum power limit heat / cool	0,0...100,0 %
Cycle time	0...200 sec
Main output type	relay, logic, continuous (0...10V Rload ≥ 250KΩ, 0/4...20mA Rload ≤ 500Ω)
Softstart	0,0...500,0 min
Fault power setting	-100,0...100,0 %
Automatic blanking	Displays PV value, optional exclusion
Configurable alarms	Up to 3 alarm functions assignable to an output, configurable as: maximum, minimum, symmetrical, absolute/deviation, LBA, HB
Alarm masking	- exclusion during warm up - latching reset from faceplate or external contact
Type of relay contact	NO (NC), 5A, 250V/30Vdc cosφ=1
Logic output for static relays	24V ±10% (10V min at 20mA)
Triac output	20...240Vac ±10%, 1A max Snubberless, inductive and resistive load Ft = 128A's
Digital Insulated Output	optoisolated MOS output 1500VRMS equivalent to NO contact Vmax 40Vac/Vdc IMax 100mA Load ON max 0,8Ω
Transmitter power supply	15/24Vdc, max 30mA short-circuit protection
Analogue retransmission signal	0...10V Rload ≥ 250KΩ, 0/4...20mA Rload ≤ 500Ω resolution 12 bit
Logic inputs	Ri = 4,7KΩ (24V, 5mA) or no-voltage contact
Serial interface (optional)	RS485, isolated
Baude rate	1200, 2400, 4800, 9600, 19200
Protocol	Gefran CENCAL / MODBUS
Optional ammeter input	T.A. 50mAac, 50/60Hz, Ri = 10Ω
Power supply (switching type)	(std) 100 ... 240Vac ±10% (opt.) 11...27Vac/dc ±10%; 50/60Hz, 8VA max
Faceplate protection	IP65
Working / Storage temperature range	0...50°C / -20...70°C
Relative humidity	20 ... 85% non-condensing
Environmental conditions of use	for internal use only, altitude up to 2000m
Installation	Panel, plug-in from front
Weight	160g for the complete version

3 · DESCRIPTION OF FACEPLATE

Function indicators
Indicates modes of operation

MAN/AUTO = OFF (automatic control)
ON (manual control)

SETPONT1/2 = OFF (IN1 = OFF - local Setpoint 1)
ON (IN1 = ON - local Setpoint 2)

SELFTUNING = ON (enabled Self)
OFF (disabled Self)

Automatic/Manual adjustment selection
Active only when PV display visualises the process variable

"Inc" and "Dec" key
Press to increment (decrement) any numerical parameter •• Increment (decrement) speed is proportional to time key stays pressed •• The operation is not cyclic: once the maximum (minimum) value of a field is reached, the value will not change even if the key remains pressed.



Indication of output states
OUT 1 (AL1); OUT 2 (Main); OUT 3 (HB); OUT 4 (HB)

PV Display: Indication of process variable
Error Indication: LO, HI, Sbr, Err
LO= the value of process variable is < di LO_S
HI= the value of process variable is > di HI_S
Sbr= faulty sensor or input values higher than max. limits
Err= PT100 third wire opened for PT100, PTC or input values lower than min. limits (i.e.: TC wrong connection)

SV display: Indication of setpoint

Function key
Gives access to the various configuration phases •• Confirms change of set parameters and browses next or previous parameter (if Auto/Man key is pressed)

4 · CONNECTIONS

• Ammeter outputs/input

User configurable generic output

- Out2 + (19) - 5A at 250Vac/30Vdc relay
- (20) - 24V, 10V at 20mA logic
- triac 20...240Vac, 1A ±10%
- Digital insulated 24Vac/dc
- Out1 (21) - 5A/250Vac relay only
- (22) - 5A at 250Vac/30Vdc relay
- 24V, 10V at 20mA logic
- continuous 0...10V, 0/4...20mA
- analog 0...10V, 0/4...20mA for transmission, resolution 12 bit
- input from current transformer 50mAac, 10 Ω 50/60 Hz
- logic input 24V, 5mA or from no-voltage contact
- Digital insulated 24Vac/dc
- Out3(AI2) (6) - Inq. T.A. (5)

• Power Supply

Standard: 23 (100...240Vac ± 10%)

Optional: PWR (24) 11...27Vac/Vdc ± 10%

Max. power 8VA; 50/60 Hz

• Serial line / output 4

Modbus	Cencal	Out 4
9 (Data +)	9 (A) - 5A at 250Vac/30Vdc TX relay	11
10 (Data -)	10 (B)	12
11 (Standard configuration)	11 (RX)	
	12 (TX)	

RS485 isolated serial line See serial card data sheet for Cencal configuration

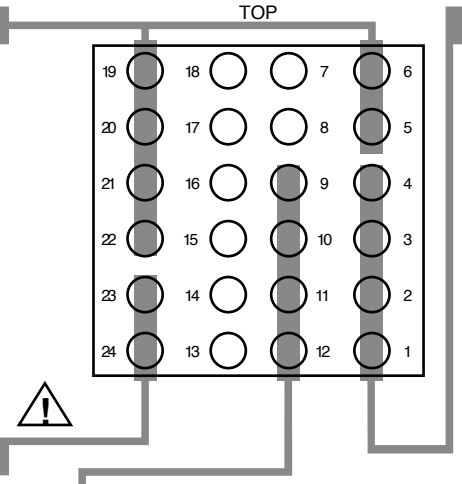

• Inputs

• TC Input

Available thermocouples: J, K, R, S, T (B, E, N, L, U, G, D, C custom linearization is available)

- Observe polarities
- For extensions, use the correct compensating cable for the type of TC used

• Linear input with 3-wire transmitter

• Linear input (I)

Linear input in dc current
20mA, Ri = 50Ω

• Input 1 linear with transmitter 2 wires

• Linear input (V)

Linear input in dc voltage
60mV, 1V
Ri > 1MΩ
5V, 10V
Ri > 10KΩ

• Pt100 / PTC / NTC

Use wires of adequate diameter (min. 1mm²)
PT100, JPT100, PTC, NTC

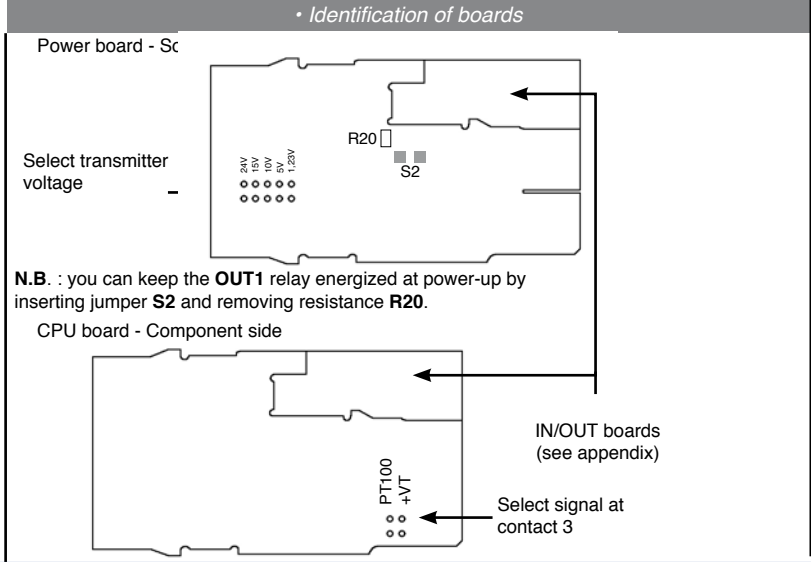
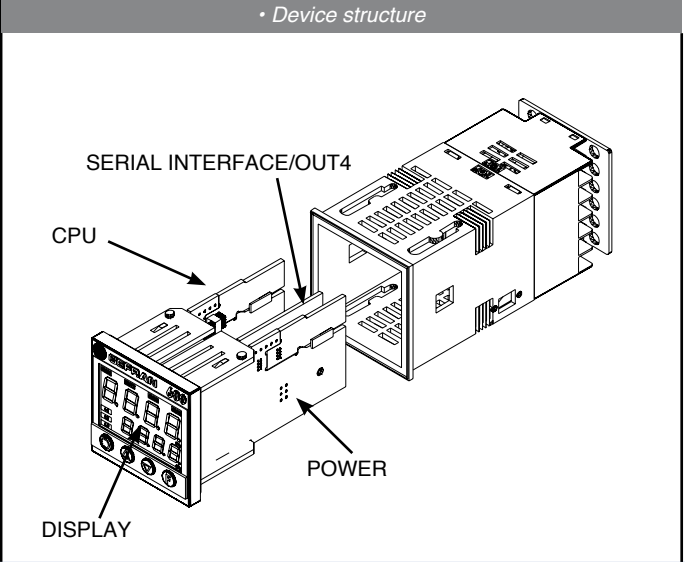

5 • “EASY” PROGRAMMING and CONFIGURATION

THE EASY CONFIGURATION IS SUITABLE FOR VERSIONS WITH TWO OUTPUTS (OUT1, OUT2). TO ACCESS THE OTHER PARAMETERS, ADD 128 TO THE **Pro** VALUE.

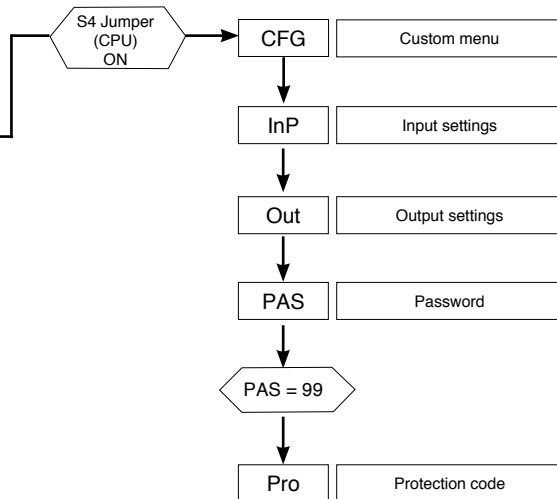
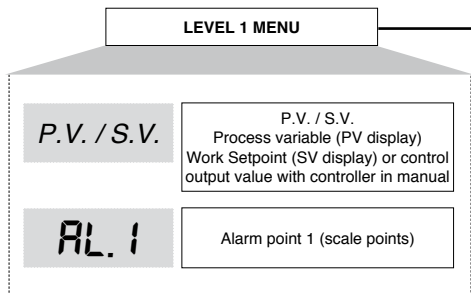

• CFG

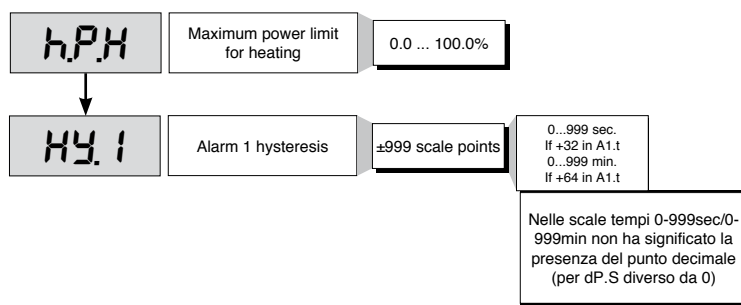
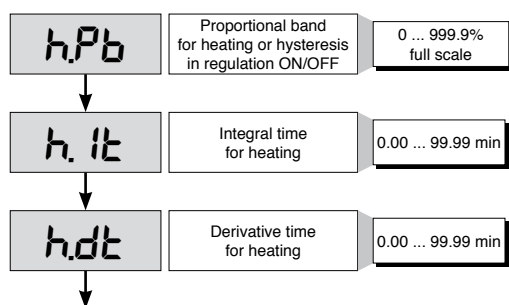

• InP

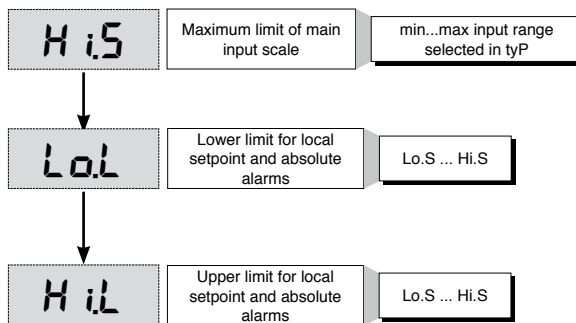
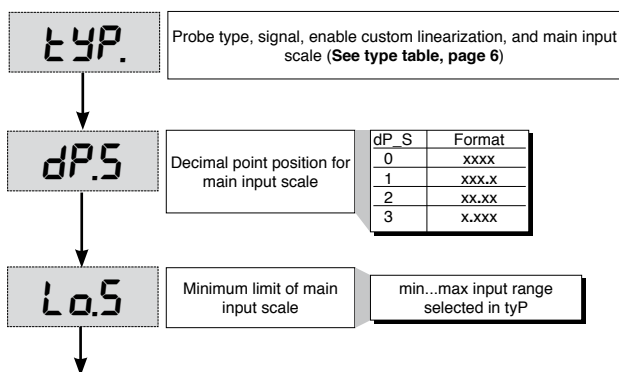

• Out

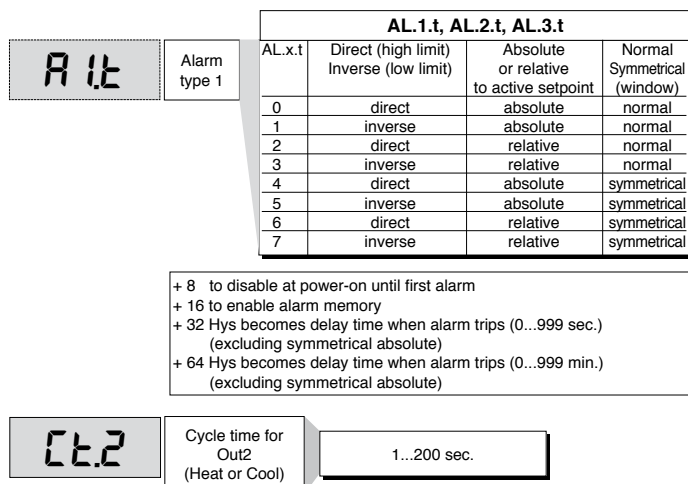

• Prot

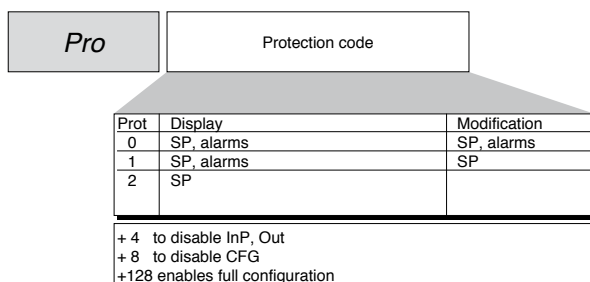

6 • PROGRAMMING and CONFIGURATION

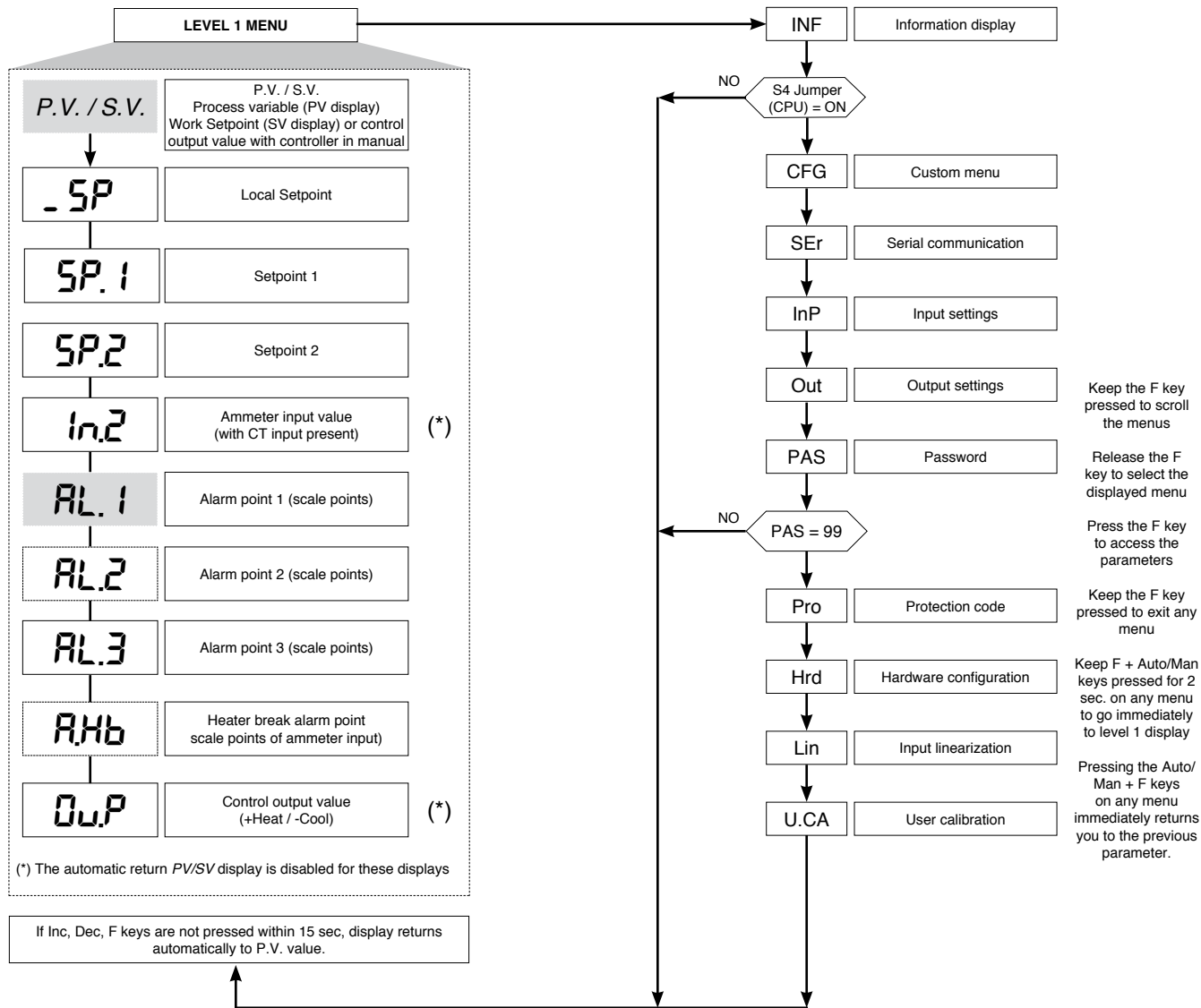

N.B.: Once a particular configuration is entered, all unnecessary parameters are no longer displayed

• InFo Display

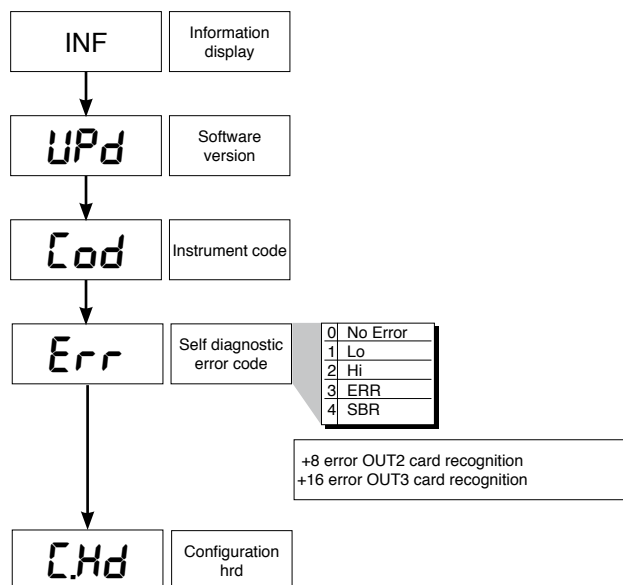
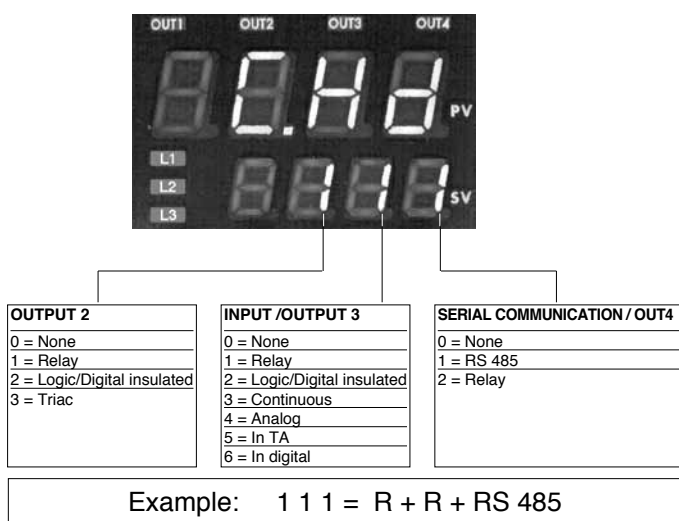

• CFG

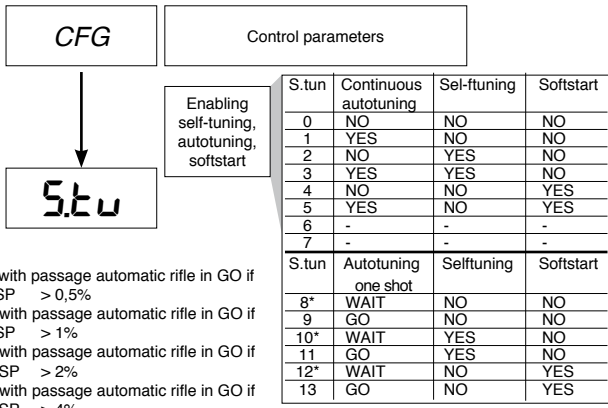

(*) +16 with passage automatic rifle in GO if PV-SP > 0,5%
 +32 with passage automatic rifle in GO if PV-SP > 1%
 +64 with passage automatic rifle in GO if PV-SP > 2%
 +128 with passage automatic rifle in GO if PV-SP > 4%

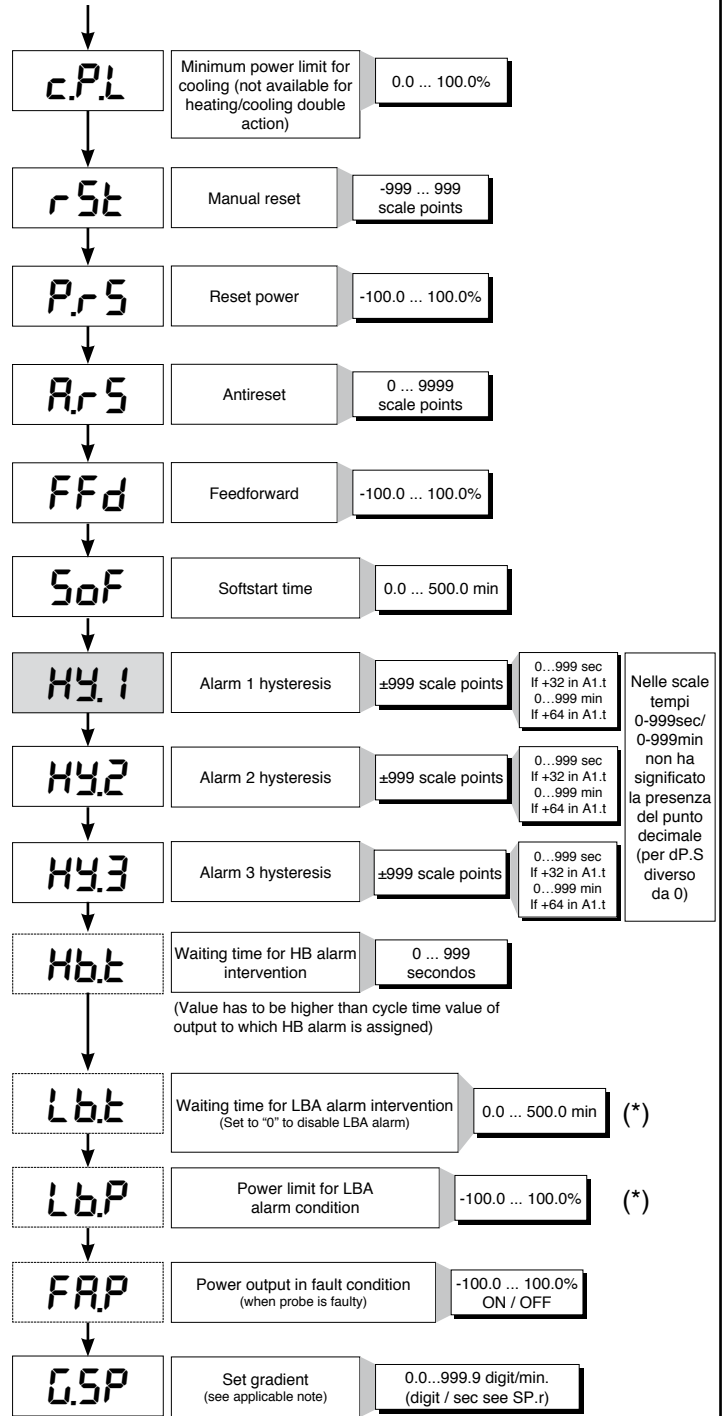
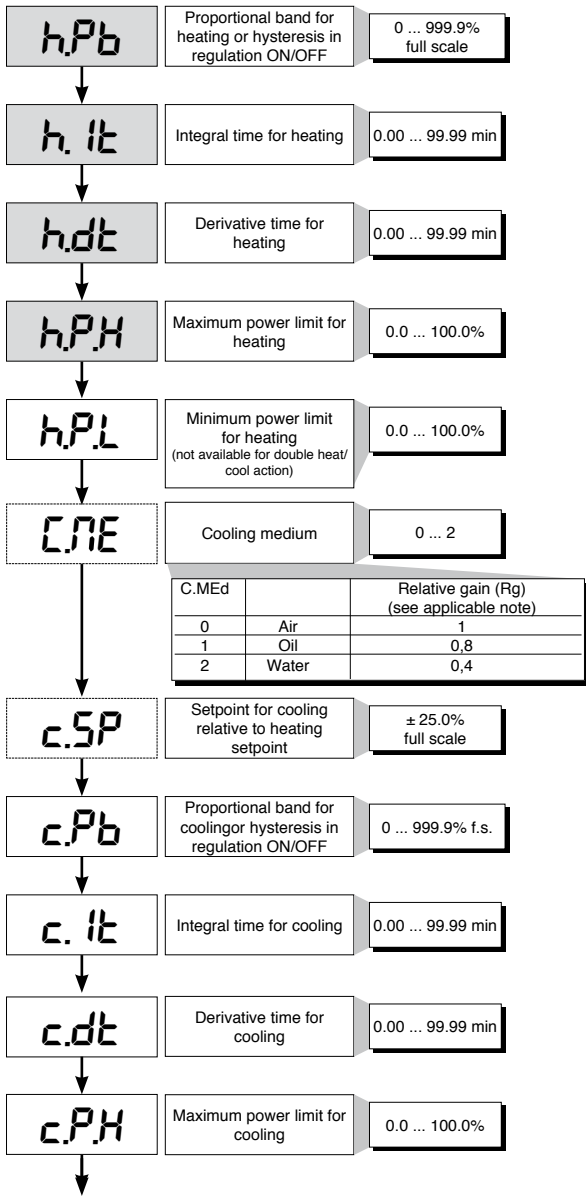

(*) LBA alarm may be reset by simultaneously pressing Δ + ▽ keys when OutP is displayed or by switching to Manual.

Nota:
 C_Pb, c_it, c_dt parameters are "read only" if the option "relative gain heat/cool control" (Ctrl = 14) has been selected.

• Ser

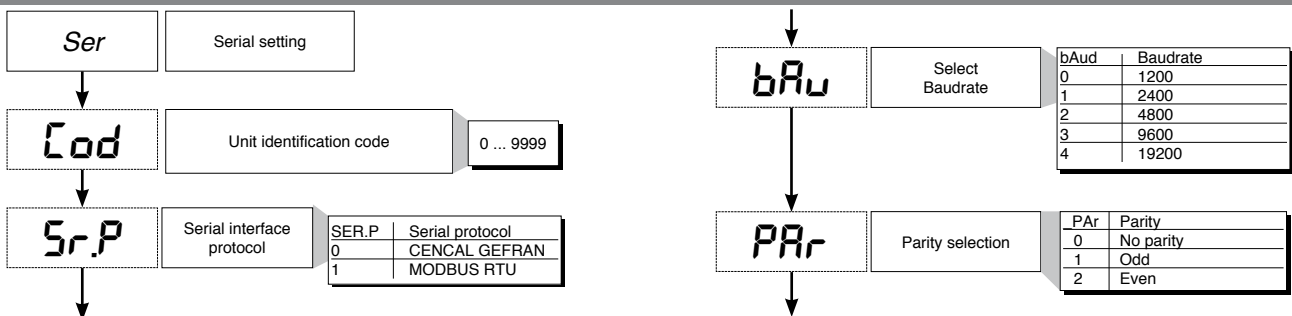

S.In Virtual instrument inputs 0 ... 31

Inputs	IN	PV	AL3	AL2	AL1
Bit	4	3	2	1	0

Ex: 1 1 0 0 0
Set code 24 in S.in. to manage serial line AN and IN

S.Ou Virtual instrument outputs 0 ... 31

Outputs	OUTW	OUT4	OUT3	OUT2	OUT1
Bit	4	3	2	1	0

Ex: 1 0 0 1 1
set code 19 in S.Ou. to manage serial line OUT1, OUT2 and OUTW.

InP

InP Input settings

SP.r Def. remote setpoint

Val.	Type of remote setpoint (from serial line)	Absolute Relative Absolute
0	Digital	Absolute
1	Digital	Relative to local setpoint

+2 set gradient in digit / sec

tYP. Probe type, signal, enable custom linearization, and main input scale

Type	Probe type	without decimal point	with decimal point
0	TC J °C	0/1000	0.0/999.9
1	TC J °F	32/1832	32.0/999.9
2	TC K °C	0/1300	0.0/999.9
3	TC K °F	32/2372	32.0/999.9
4	TC R °C	0/1750	0.0/999.9
5	TC R °F	32/3182	32.0/999.9
6	TC S °C	0/1750	0.0/999.9
7	TC S °F	32/3182	32.0/999.9
8	TC T °C	-200/400	-199.9/400.0
9	TC T °F	-328/752	-199.9/752.0
28	TC	CUSTOM	CUSTOM
29	TC	CUSTOM	CUSTOM
30	PT100 °C	-200/850	-199.9/850.0
31	PT100 °F	-328/1562	-199.9/999.9
32	JPT100 °C	-200/600	-199.9/600.0
33	JPT100 °F	-328/1112	-199.9/999.9
34	PTC °C	-55/120	-55.0/120.0
35	PTC °F	-67/248	-67.0/248.0
36	NTC °C	-10/70	-10.0/70.0
37	NTC °F	14/158	14.0/158.0
38	0...60 mV	-1999/9999	-199.9/999.9
39	0...60 mV	Custom scale	Custom scale
40	12...60 mV	-1999/9999	-199.9/999.9
41	12...60 mV	Custom scale	Custom scale
42	0...20 mA	-1999/9999	-199.9/999.9
43	0...20 mA	Custom scale	Custom scale
44	4...20 mA	-1999/9999	-199.9/999.9
45	4...20 mA	Custom scale	Custom scale
46	0...10 V	-1999/9999	-199.9/999.9
47	0...10 V	Custom scale	Custom scale
48	2...10 V	-1999/9999	-199.9/999.9
49	2...10 V	Custom scale	Custom scale
50	0...5 V	-1999/9999	-199.9/999.9
51	0...5 V	Custom scale	Custom scale
52	1...5 V	-1999/9999	-199.9/999.9
53	1...5 V	Custom scale	Custom scale
54	0...1 V	-1999/9999	-199.9/999.9
55	0...1 V	Custom scale	Custom scale
56	200mV..1V	-1999/9999	-199.9/999.9
57	200mV..1V	Custom scale	Custom scale
58	Cust10 V-20mA	-1999/9999	-199.9/999.9
59	Cust10 V-20mA	Custom scale	Custom scale
60	Cust 60mV	-1999/9999	-199.9/999.9
61	Cust 60mV	Custom scale	Custom scale
62	PT100-JPT	CUSTOM	CUSTOM
63	PTC	CUSTOM	CUSTOM
64	NTC	CUSTOM	CUSTOM

For custom linearization:
- LO signal is generated with variable below Lo.S or at minimum calibration value
- HI signal is generated with variable above Lo.S or at maximum calibration value

S.U.1 Virtual instrument user interface 0 ... 63

Interf.	LED 1/2/3	KEYB	DISL	DISH	LED OUT4	LED OUT3	LED OUT2	LED OUT1
Bit	7	6	5	4	3	2	1	0

Ex: 1 0 1 0 0 0
If you want to manage KEYB and DISH from serial line, set code 80 in S.U.1.

Max. non-linearity error for thermocouples (TC), resistors (PT100) and thermistors (PTC, NTC).
The error is calculated as deviation from theoretical value and is expressed as percentage of full scale (in °C).

S, R range 0...1750°C; error < 0.2% f.s. (t > 300°C) / for other range; error < 0.5% f.s.
T error < 0.2% f.s. (t > -150°C)
B range 44...1800°C; error < 0.5% f.s. (t > 300°C) / range 44,0...999,9; error < 1% f.s. (t > 300°C)
U range -99,9...99,9 and -99...99°C; error < 0.5% f.s. / for other range; error < 0.2% f.s. (t > -150°C)
G error < 0.2% f.s. (t > 300°C)
D error < 0.2% f.s. (t > 200°C)
C range 0...2300; error < 0.2% f.s. / for other range; error < 0.5% f.s.

NTC error < 0.5% f.s.

Tc: J, K, E, N, L error < 0,2% f.s.
JPT100 and PTC error < 0,2% f.s.
PT100 scale -200...850°C
Precision better than 0,2% f.s. at 25°C
In range 0...50°C:
• Precision better than 0,2% f.s. in range -200...400°C
• Precision better than 0,4% f.s. in range +400...850°C (where f.s. refers to range -200...+850°C)

Filt Digital filter on input (if = 0 excludes averaging filter on sample value) 0.0 ... 20.0 sec

Fld Digital filter on input display 0 ... 9.9 scale points

dP.S Decimal point position for input scale

dP_S	Format
0	xxxx
1	xxx.x
2	xx.xx (*)
3	x.xxx (*)

(*) not available for TC, RTD, PTC and NTC scales

Lo.S Minimum limit of main input scale min...max input range selected in tyP

Hi.S Maximum limit of main input scale min...max input range selected in tyP

oFS. Offset correction of main input -999 ... 999 scale points

Ft.2 Digital filter aux. input 0.0 ... 20.0 sec

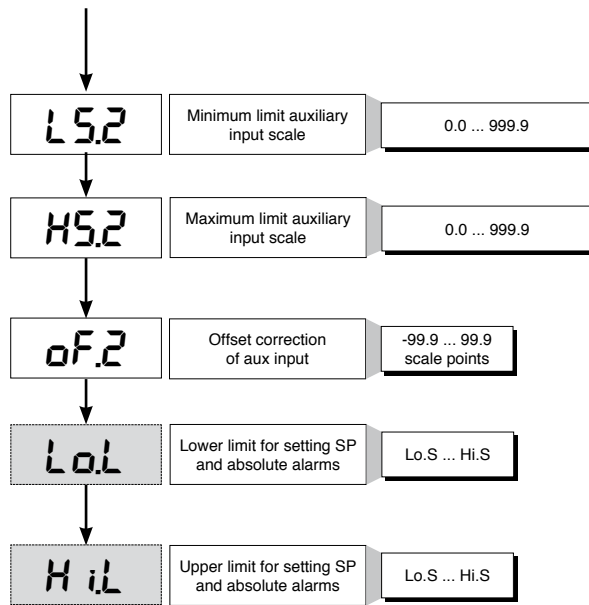

• Out

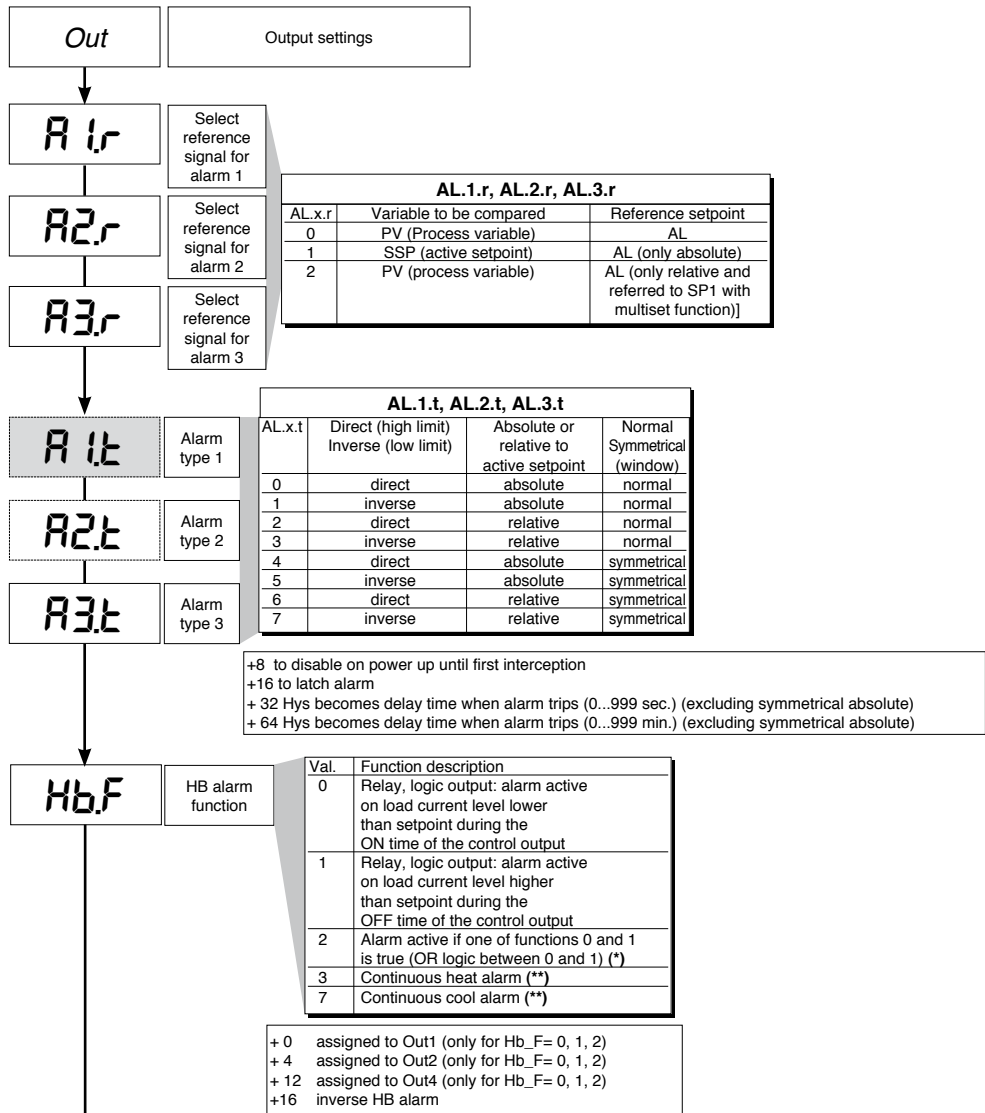

Notes:
 - The HB alarm is disabled if assigned to a rapid output (except codes 3 and 7)
 - When the CT input is present, faceplate LED OUT3 always indicates the state of the HB alarm.

(*) minimum setting is fixed at 12% of amperometric full scale
 (**) As type 0 without reference to cycle time

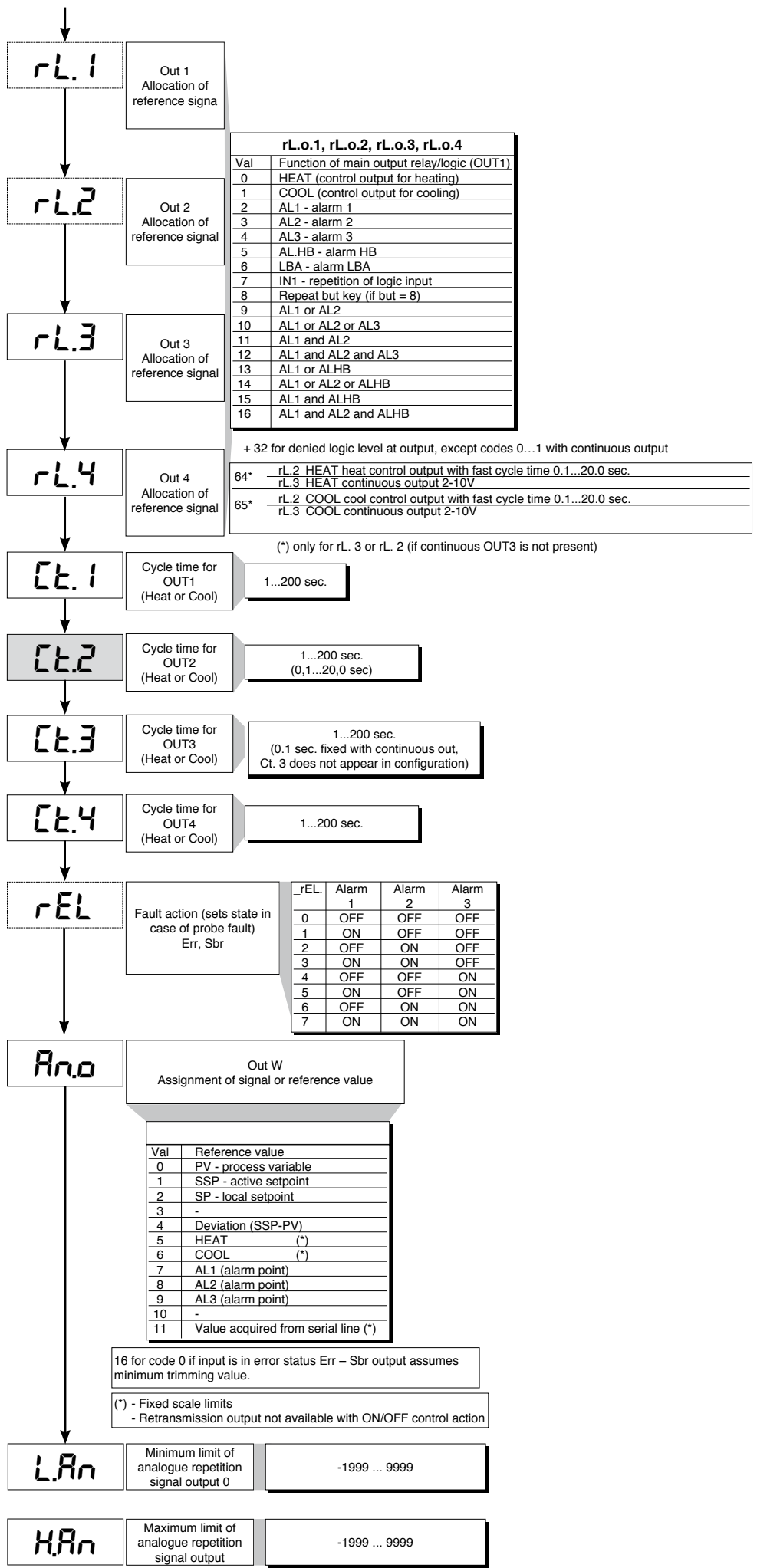

• Prot

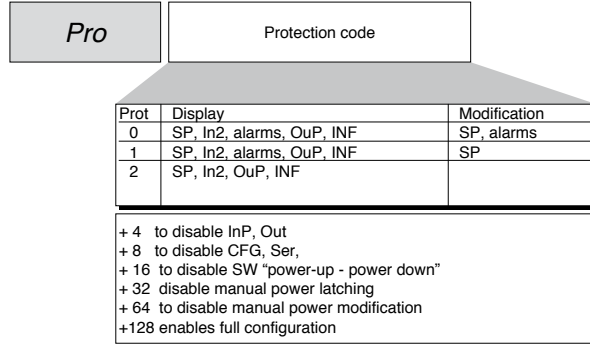

• Hrd

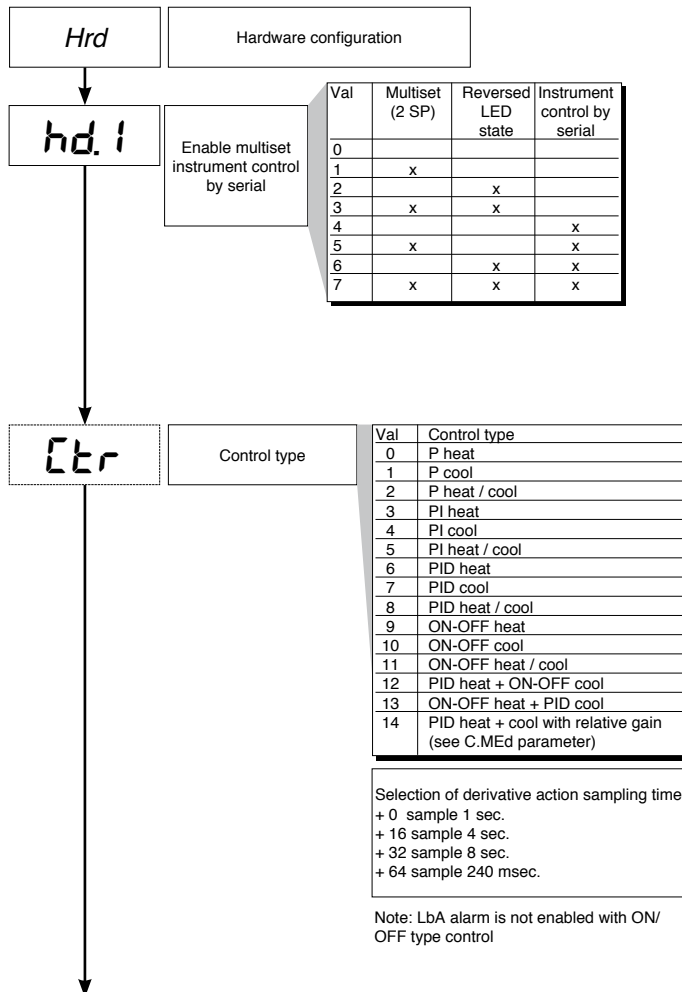

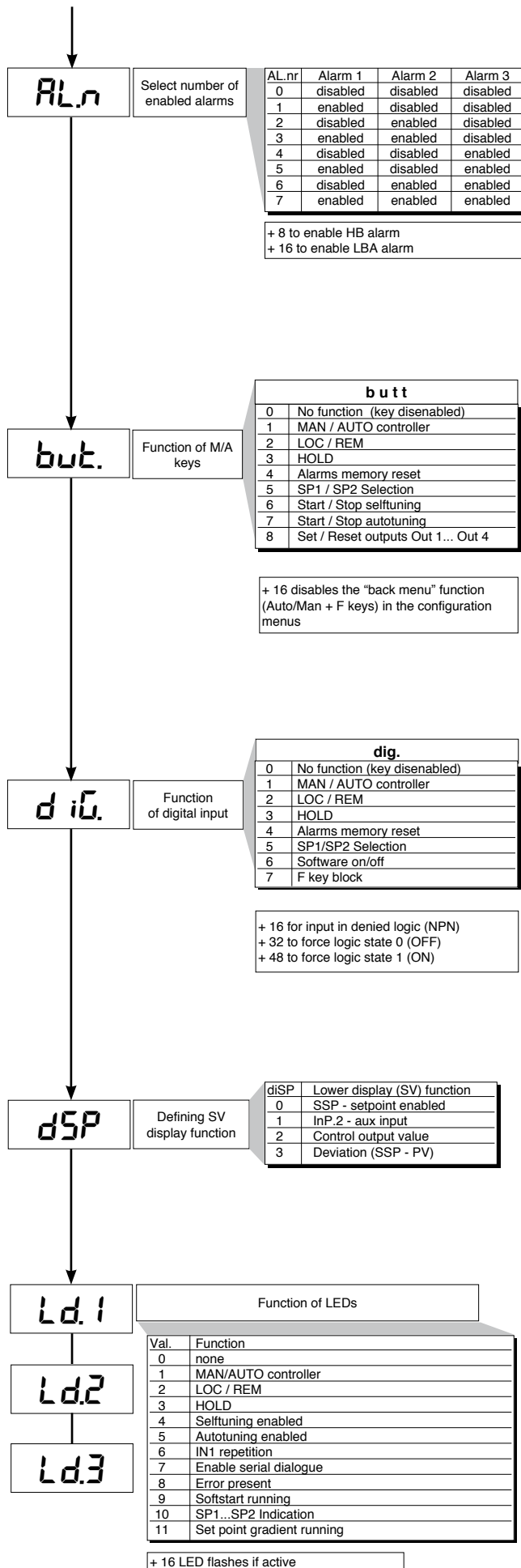

• Lin

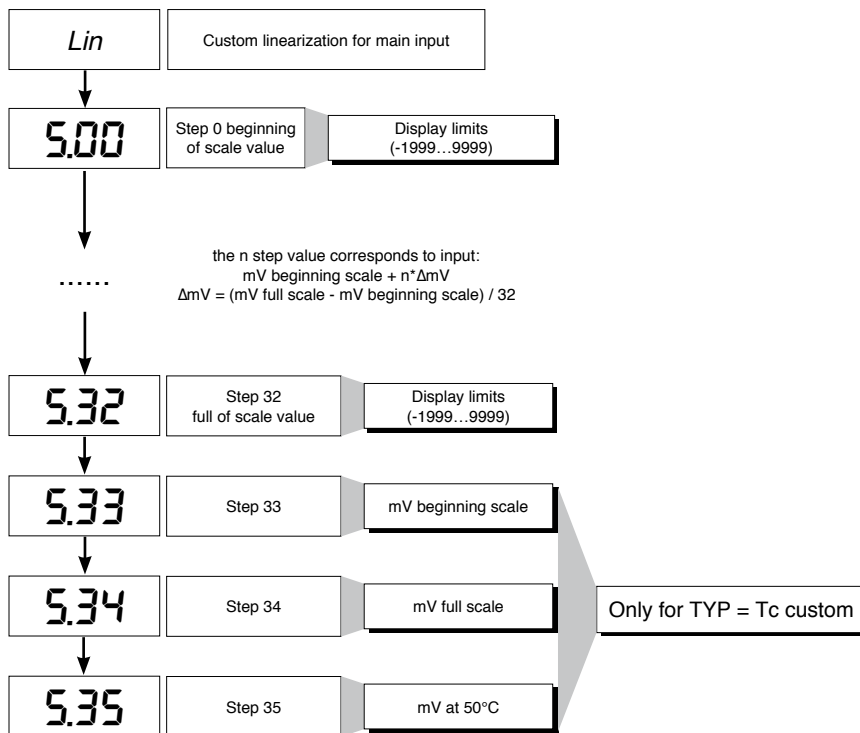

• U.CAL

<i>U.CA</i>	User calibration	Val	Function
		1	Analogue output (1)
		2	Input 1 – custom 10V / 20mA
		3	Input 1 - custom 60mV
		4	Custom PT100 / J PT100
		5	Custom PTC
		6	Custom NTC
		7	Input 2 - custom TA (2)

- (1) The analog output in 20mA is calibrated with accuracy higher than 0.2 % f.s.; calibrate when converting to 10V output.
- (2) In the absence of calibration, accuracy is higher than 1% f.s.; calibrate only if higher accuracy is required.

HB ALARM FUNCTION

This type of alarm depends on use of the current transformer (C.T.) input.

It can signal variations in load input by identifying the current value in ammeter input in the range (0 ... HS.2). It is enabled by means of configuration code (AL.n); in this case, the alarm trip value is expressed in HB scale points.

By means of code Hb.F ("Out" phase), select the type of functioning and the assigned control output.

The alarm limit setting is A.Hb.

The direct HB alarm trips when the ammeter input value is below the limit set for Hb.t seconds of the "ON" time for the selected output.

The HB alarm can be activated only with ON times greater than 0.4 seconds (excludes continuous output).

The HB alarm also checks load current during the OFF interval of the cycle time for the selected output. The HB alarm trips if the measured current exceeds approximately 12.5% of the full scale set for HB.t seconds of OFF status of the output (parameter HS.2 in InP).

The alarm is reset automatically if its cause is eliminated.

Setting limit A.Hb = 0 disables both types of HB alarms, with de-energizing of the assigned relay.

You can display the load current by selecting the item In.2. (level 1).

NOTE: ON/OFF times refer to the cycle time set for the selected output.

Continuous alarm Hb_F = 3 (7) is active for a load current value below the set limit. It is disabled if the heating (cooling) output value is below 3%.

• HOLD function

The input value and alarms are frozen while the logic input is closed.

With logic input closed, a reset turns OFF both the relay outputs and the alarms latch.

7 • ALARMS

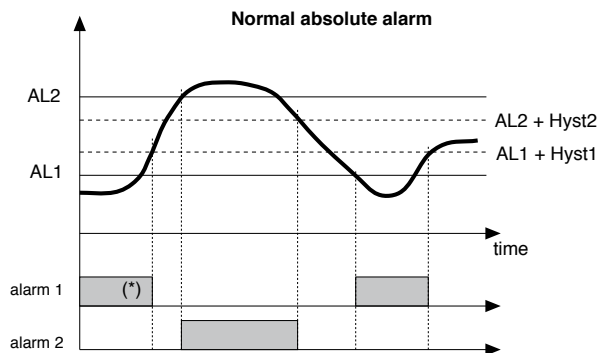

For AL1 = reverse absolute alarm (low) with positive Hyst1, AL1 t = 1
 (*) = OFF if disabled on power-up
 For AL2 = direct absolute alarm (high) with negative Hyst2, AL2 t = 0

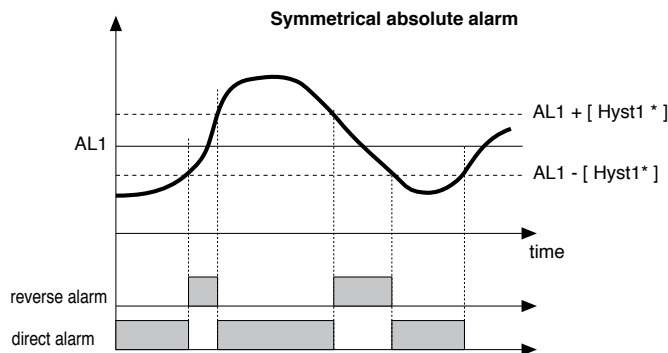

For AL1 = symmetrical Lo absolute alarm with Hyst1, AL1 t = 5
 For AL1 = symmetrical Hi absolute alarm with Hyst1, AL1 t = 4

* Minimum hysteresis = 2 scale points

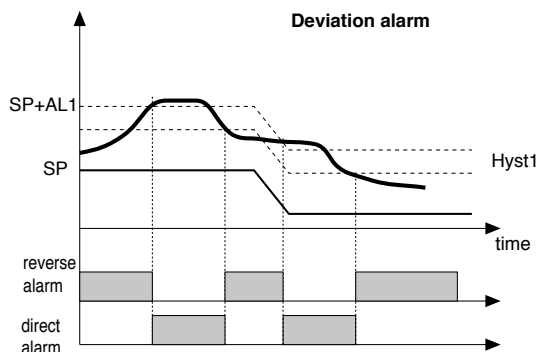

For AL1 = Lo deviation alarm with negative Hyst 1, AL1 t = 3
 For AL1 = Hi deviation alarm with negative Hyst 1, AL1 t = 2

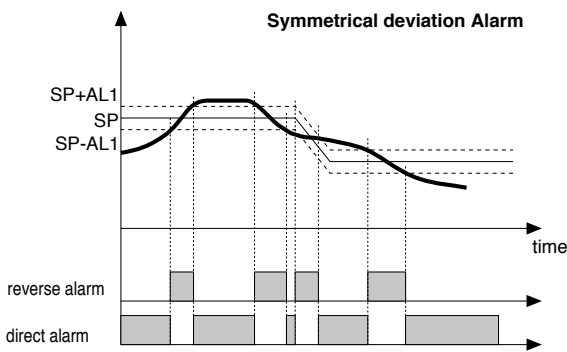

For AL1 = Symmetrical Lo deviation alarm with Hyst 1, AL1 t = 7
 For AL1 = Symmetrical Hi deviation alarm with Hyst 1, AL1 t = 6

8 • CONTROL ACTIONS

Proportional Action:

action in which contribution to output is proportional to deviation at input (deviation = difference between controlled variable and setpoint).

Derivative Action:

action in which contribution to output is proportional to rate of variation input deviation.

Integral Action:

action in which contribution to output is proportional to integral of time of input deviation.

Influence of Proportional, Derivative and Integral actions on response of process under control

- * An increase in P.B. reduces oscillations but increases deviation.
 - * A reduction in P.B. reduces the deviation but provokes oscillations of the controlled variable (the system tends to be unstable if P.B. value is too low).
 - * An increase in Derivative Action corresponds to an increase in Derivative Time, reduces deviation and prevents oscillation up to a critical value of Derivative Time, beyond which deviation increases and prolonged oscillations occur.
 - * An increase in Integral Action corresponds to a reduction in Integral Time, and tends to eliminate deviation between the controlled variable and the setpoint when the system is running at rated speed.
- If the Integral Time value is too long (Weak integral action), deviation between the controlled variable and the setpoint may persist.
Contact GEFTRAN for more information on control actions.

9 • MANUAL TUNING

- A) Enter the setpoint at its working value.
- B) Set the proportional band at 0.1% (with on-off type setting).
- C) Switch to automatic and observe the behavior of the variable. It will be similar to that in the figure:

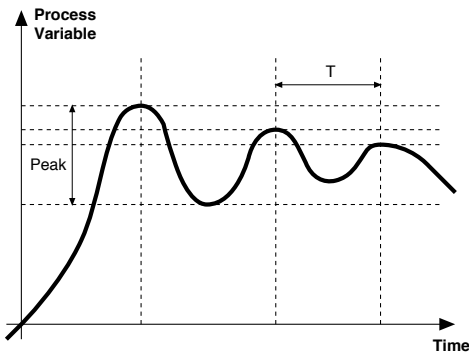

- D) The PID parameters are calculated as follows: Proportional band

$$P.B. = \frac{\text{Peak}}{(V \text{ max} - V \text{ min})} \times 100$$

(V max - V min) is the scale range.

Integral time: $I_t = 1.5 \times T$

Derivative time: $d_t = I_t/4$

- E) Switch the unit to manual, set the calculated parameters. Return to PID action by setting the appropriate relay output cycle time, and switch back to Automatic.

- F) If possible, to optimize parameters, change the setpoint and check temporary response. If an oscillation persists, increase the proportional band. If the response is too slow, reduce it.

10 • MULTISET FUNCTION, SET GRADIENT

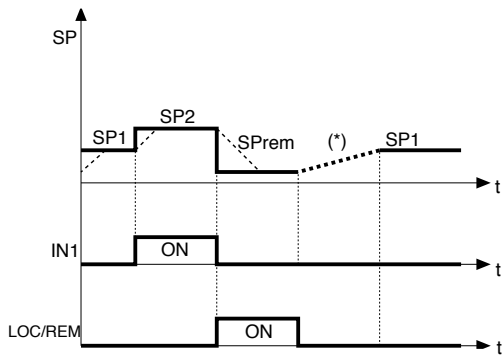

(*) if the set gradient is set

The multiset function is enabled in hd.1.

The gradient function is always enabled.

You can select between setpoint 1 and setpoint 2 with the faceplate key or with digital input.

You can display the setpoint 1-2 selection by means of LED.

SET GRADIENT: if set to $\neq 0$, the setpoint is assumed equal to PV at power-on and auto/man switchover. With gradient set, it reaches the local setpoint or the one selected.

Every variation in setpoint is subject to a gradient.

The set gradient is inhibited at power-on when self-tuning is engaged.

If the set gradient is set to $\neq 0$, it is active even with variations of the local setpoint, settable only on the relative SP menu.

The control setpoint reaches the set value at the speed defined by the gradient.

11 • SOFTWARE ON / OFF SWITCHING FUNCTION

How to switch the unit OFF: hold down the "F" and "Raise" keys simultaneously for 5 seconds to deactivate the unit, which will go to the OFF state while keeping the line supply connected and keeping the process value displayed. The SV display is OFF.

All outputs (alarms and controls) are OFF (logic level 0, relays de-energized) and all unit functions are disabled except the switch-on function and digital communication.

How to switch the unit ON: hold down the "F" key for 5 seconds and the unit will switch OFF to ON. If there is a power failure during the OFF state, the unit will remain in OFF state at the next power-up (ON/OFF state is memorized).

The function is normally enabled, but can be disabled by setting the parameter Prot = Prot +16. This function can be assigned to a digital input (d.i.G) and excludes deactivation from the keyboard.

12 · SELF-TUNING

The function works for single output systems (heating or cooling). The self-tuning action calculates optimum control parameter values during process startup. The variable (for example, temperature) must be that assumed at zero power (room temperature). The controller supplies maximum power until an intermediate value between starting value and setpoint is reached, after which it zeros power. PID parameters are calculated by measuring overshoot and the time needed to reach peak. When calculations are finished, the system disables automatically and the control proceeds until the setpoint is reached.

How to activate self-tuning:

A. Activation at power-on

1. Set the setpoint to the required value
2. Enable selftuning by setting the Stun parameter to 2 (CFG menu)
3. Turn off the instrument
4. Make sure the temperature is near room temperature
5. Turn on the instrument again

B. Activation from keyboard

1. Make sure that key M/A is enabled for Start/Stop selftuning (code but = 6 Hrd menu)
2. Bring the temperature near room temperature
3. Set the setpoint to the required value
4. Press key M/A to activate selftuning (Attention: selftuning interrupts if the key is pressed again)

The procedure runs automatically until finished, when the new PID parameters are stored: proportional band, integral and derivative times calculated for the active action (heating or cooling). In case of double action (heating or cooling), parameters for the opposite action are calculated by maintaining the initial ratio between parameters (ex.: $CPb = HPb * K$; where $K = CPb / HPb$ when self-tuning starts). When finished, the Stun code is automatically cancelled.

Notes :

- The procedure does not start if the temperature is higher than the setpoint (heating control mode) or if the temperature is lower than the setpoint (cooling control mode). In this case, the Stu code is not cancelled.
- It is advisable to enable one of the configurable LEDs to signal selftuning status. By setting one of parameters LED1, LED2, LED3=4 or 20 on the Hrd menu, the respective LED will be on or flashing when selftuning is active.

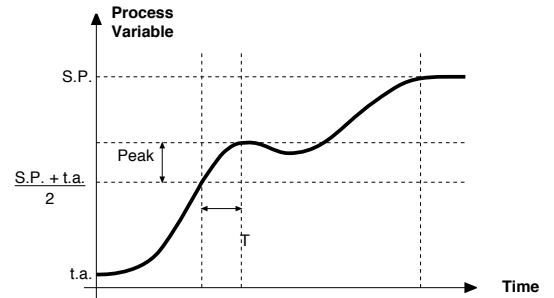

13 · AUTO-TUNING

Enabling the auto-tuning function blocks the PID parameter settings. It can be one of two types: permanent (continuous) or single-action (one-shot).

* Continuous auto-tuning is activated via the Stu parameter (values 1, 3, 5). It continuously reads system oscillations, immediately seeking the PID parameter values that reduce the current oscillation. It does not engage if the oscillations drop below 1.0% of the proportional band. It is interrupted if the set-point is changed, and automatically resumes with a constant set-point. The calculated parameters are not saved if the instrument is switched off, if the instrument is switched to manual, or if the configuration code is disabled. The controller resumes with the parameters programmed before auto-tuning was enabled. The calculated parameters are saved when the function is enabled from the digital input or from the A/M (start/stop) key if the procedure is interrupted.

* One-shot auto-tuning can be enabled manually or automatically. It is

activated via the Stu parameter (as can be seen on the table, the values to be set depend on whether Self-tuning or Soft-start is enabled.). It is useful for calculation of PID parameters when the system is around the set-point. It produces a variation on the control output at a maximum of $\pm 100\%$ of the current control power limited by h.PH - h.PL (hot), c.PH - c.PL (cold), and assesses the effects in timed overshoot. The calculated parameters are saved. Manual activation (Stu code = 8, 10, 12) via direct setting of the parameter or via digital input or via key. Automatic activation (Stu code = 24, 26, 28 with error band of 0.5%) when the PV-SP error exceeds the preset band (programmable to 0.5%, 1%, 2%, 4% of full scale).

NB: at power-up, or after a change of set-point, automatic activation is inhibited for a time equal to five times the integral time, with a minimum of 5 minutes. The same time has to run after one-shot.

14 · CONTROLS

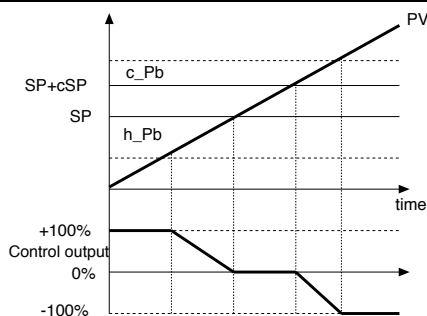

Control output with proportional action only if proportional heating band overlaps proportional cooling band.

PV = Process Value
 SP+cSP = cooling setpoint
 c_Pb = Proportional cooling band

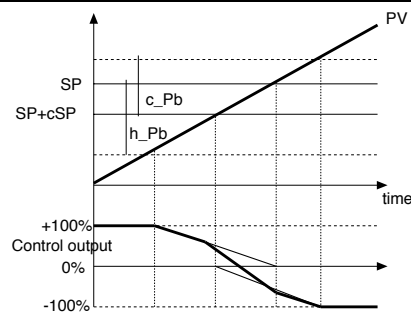

Control output with proportional action only if proportional heating band overlaps proportional cooling band.

SP = Heating Setpoint
 h_Pb = proportional heating band

Heating/Cooling control with relative gain

In this control mode (enabled with Ctr = 14 parameter) the type of cooling has to be specified.

Cooling PID parameters are therefore calculated based on heating parameters according to the specified ratio.

(for example: C.ME = 1 (oil), H_Pb = 10, H_dt = 1, H_lt = 4 implies: C_Pb = 12.5, C_dt = 1, C_lt = 4)

We advise you to apply the following values when setting output cycle times:

Air T Cool Cycle = 10 sec.

Oil T Cool Cycle = 4 sec

Water T Cool Cycle = 2 sec.

NB.: Cooling parameters **cannot be modified** in this mode.

15 • ACCESSORIES

• CURRENT TRANSFORMER

These transformers are used to measure currents of 50 ÷ 60Hz from 25A to 600A (nominal primary current). The peculiar characteristic of these transformers is the high number of secondary turns. This provides a very low secondary current, suitable for an electronic measurement circuit. The secondary current may be detected as voltage on a resistor.

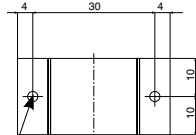
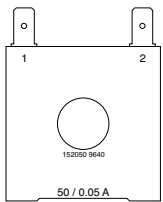

Hole for 2.9 x 9 self-threading screws

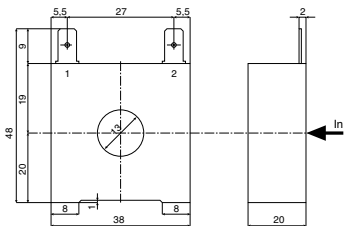

CODE	Ip / Is	Ø Secondary Wire	n	OUTPUTS	Ru	Vu	ACCURACY
TA/152 025	25 / 0.05A	0.16 mm	n ¹⁻² = 500	1 - 2	40 Ω	2 Vac	2.0 %
TA/152 050	50 / 0.05A	0.18 mm	n ¹⁻² = 1000	1 - 2	80 Ω	4 Vac	1.0 %

• ORDER CODE

COD. 330200	IN = 50Aac OUT = 50mAac
COD. 330201	IN = 25Aac OUT = 50mAac

• PTC

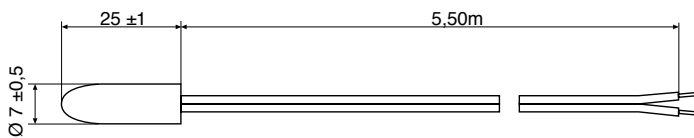

• ORDER CODE

PTC 7 x 25 5m

TECHNICAL DATA

Mod. probe:	Ambient probe
Cap material:	Plastic (Ø 7 x 25mm)
Temperature range:	-20...80°C
PTC:	R 25°C = 1KΩ ±1% (KTY 81-110)
Response time:	20sec (in still air)
Isolation:	100MΩ, 500Vd.c. between cap and terminals
Wire material:	Unipolar in PVC (12/0,18)
Wire length:	5,50m

• Interface for GEFTRAN instrument configuration

KIT PC USB / RS485 o TTL



Kit for PC via the USB port (Windows environment) for GEFTRAN instruments configuration:

- Lets you read or write all of the parameters
- A single software for all models
- Easy and rapid configuration
- Saving and management of parameter recipes
- On-line trend and saving of historical data

Component Kit:

- Connection cable PC USB ... port TTL
- Connection cable PC USB ... RS485 port
- Serial line converter
- CD SW GF Express installation

• ORDERING CODE

GF_eXK-2-0-0 cod F049095

16 • APPLICATIONS

• Twin setpoint application (ramp + hold + time expiration alarm)

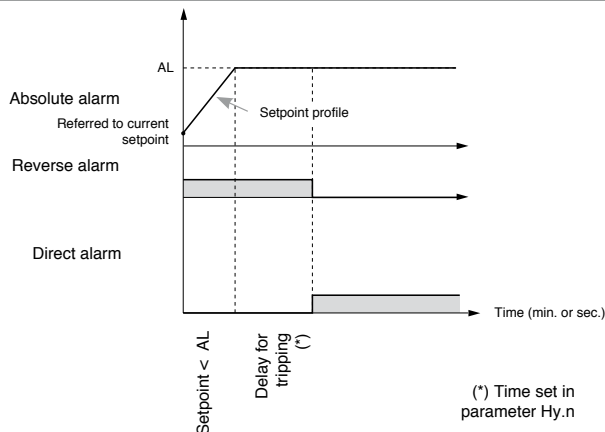

The controller is available in 2 versions:

BASIC VERSION

Up to 3 output options; option 4 not available. Unit with 12 terminals rear socket.

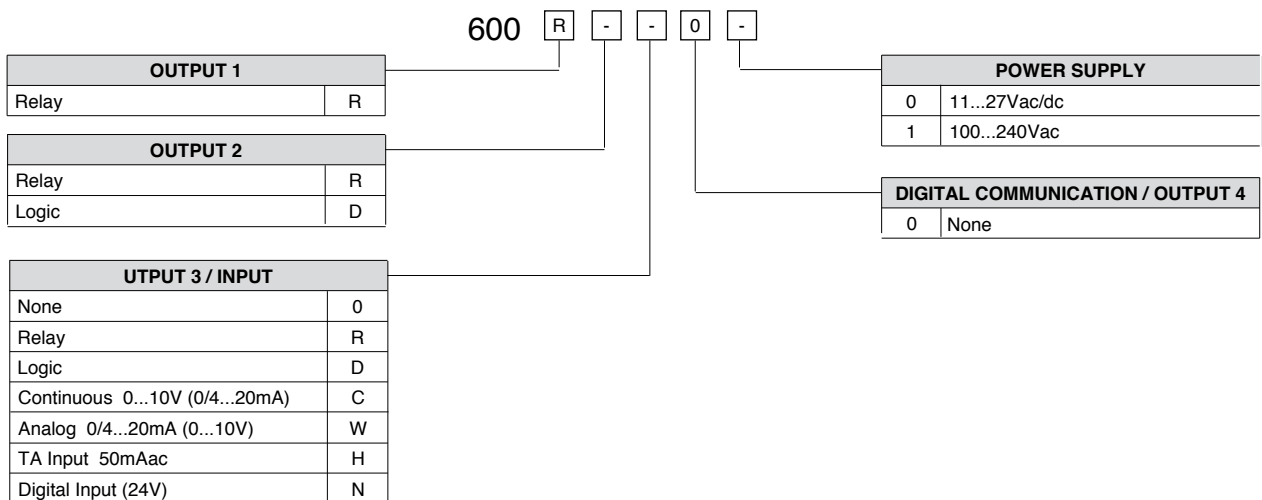

EXPANDABLE VERSION

Up to 4 output options. Unit with internal plug and complete rear socket.

With this version, option 4 can be added at a later stage.

For optional I/O boards, please see "Accessories" section.

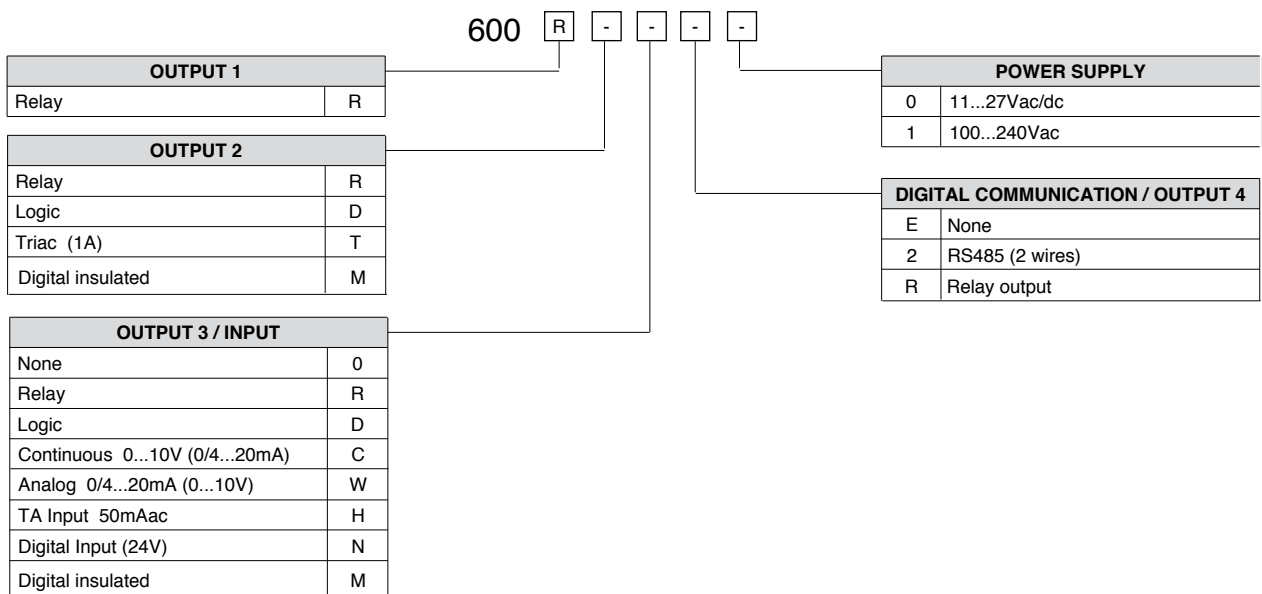

Please, contact GEFTRAN sales people for the codes availability.
 For correct installation, follow the instructions contained in the manual.

• WARNINGS



WARNING: this symbol indicates danger. It is placed near the power supply circuit and near high-voltage relay contacts.

Read the following warnings before installing, connecting or using the device:

- follow instructions precisely when connecting the device.
- always use cables that are suitable for the voltage and current levels indicated in the technical specifications.
- the device has no ON/OFF switch: it switches on immediately when power is turned on. For safety reasons, devices permanently connected to the power supply require a two-phase disconnecting switch with proper marking. Such switch must be located near the device and must be easily reachable by the user. A single switch can control several units.
- if the device is connected to electrically NON-ISOLATED equipment (e.g. thermocouples), a grounding wire must be applied to assure that this connection is not made directly through the machine structure.
- if the device is used in applications where there is risk of injury to persons and/or damage to machines or materials, it MUST be used with auxiliary alarm units. You should be able to check the correct operation of such units during normal operation of the device.
- before using the device, the user must check that all device parameters are correctly set in order to avoid injury to persons and/or damage to property.
- the device must NOT be used in inflammable or explosive environments. It may be connected to units operating in such environments only by means of suitable interfaces in conformity to local safety regulations.
- the device contains components that are sensitive to static electrical discharges. Therefore, take appropriate precautions when handling electronic circuit boards in order to prevent permanent damage to these components.

Installation: installation category II, pollution level 2, double isolation

The equipment is intended for permanent indoor installations within their own enclosure or panel mounted enclosing the rear housing and exposed terminals on the back.

- only for low power supply: supply from Class 2 or low voltage limited energy source
- power supply lines must be separated from device input and output lines; always check that the supply voltage matches the voltage indicated on the device label.
- install the instrumentation separately from the relays and power switching devices
- do not install high-power remote switches, contactors, relays, thyristor power units (particularly if "phase angle" type), motors, etc... in the same cabinet.
- avoid dust, humidity, corrosive gases and heat sources.
- do not close the ventilation holes; working temperature must be in the range of 0...50°C.
- surrounding air: 50°C
- use 60/75°C copper (Cu) conductor only, wire size range 2x No 22 - 14AWG, Solid/Stranded
- use terminal tightening torque 0.5N m

If the device has faston terminals, they must be protected and isolated; if the device has screw terminals, wires should be attached at least in pairs.

• **Power:** supplied from a disconnecting switch with fuse for the device section; path of wires from switch to devices should be as straight as possible; the same supply should not be used to power relays, contactors, solenoid valves, etc.; if the voltage waveform is strongly distorted by thyristor switching units or by electric motors, it is recommended that an isolation transformer be used only for the devices, connecting the screen to ground; it is important for the electrical system to have a good ground connection; voltage between neutral and ground must not exceed 1V and resistance must be less than 60Ω; if the supply voltage is highly variable, use a voltage stabilizer for the device; use line filters in the vicinity of high frequency generators or arc welders; power supply lines must be separated from device input and output lines; always check that the supply voltage matches the voltage indicated on the device label.

• **Input and output connections:** external connected circuits must have double insulation; to connect analog inputs (TC, RTD) you have to: physically separate input wiring from power supply wiring, from output wiring, and from power connections; use twisted and screened cables, with screen connected to ground at only one point; to connect adjustment and alarm outputs (contactors, solenoid valves, motors, fans, etc.), install RC groups (resistor and capacitor in series) in parallel with inductive loads that work in AC (Note: all capacitors must conform to VDE standards (class x2) and support at least 220 VAC. Resistors must be at least 2W); fit a 1N4007 diode in parallel with the coil of inductive loads that operate in DC.

GEFRAN spa will not be held liable for any injury to persons and/or damage to property deriving from tampering, from any incorrect or erroneous use, or from any use not conforming to the device specifications.

**• SCHEDE INGRESSI / USCITE • INPUT/OUTPUT BOARDS • CARTES D'ENTREES/SORTIES
• E/A-KARTEN • FICHAS ENTRADAS/SALIDAS • PLACAS DE ENTRADAS/SAÍDAS**

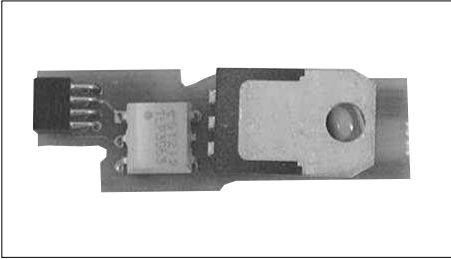

USCITA TRIAC (OUT2)
TRIAC OUTPUT (OUT2)
SORTIE TRIAC (OUT2)
TRIAC-AUSGANG (OUT2)
SALIDA TRIAC (OUT2)
SAÍDA TRIAC (OUT2)

PROFILO

Questa scheda supporta la funzione di uscita prevista come OUT2 nello strumento 600. Adatta a pilotare carichi in ac sino ad un massimo di 240 V a.c., 1A. La schedina è automaticamente riconosciuta dallo strumento che abilita visibilità ed impostazione dei parametri relativi.

PROFILE

This board supports the output function provided as OUT2 on the 600 instrument. Suitable for piloting AC loads up to a maximum of 240 V a.c., 1A. The board is automatically recognized by the instrument, which enables display and setting of the parameters involved.

GENERALITES

Cette carte supporte la fonction sortie prévue comme OUT2 dans l'outil 600. Elle est apte à piloter les charges en ca jusqu'à un maximum de 240 V a.c., 1A. La carte est automatiquement reconnue par l'outil qui habilite la visibilité et la programmation des paramètres appropriés.

BESCHREIBUNG

Diese Karte unterstützt die als OUT2 beim Instrument 600 vorgesehene Ausgangsfunktion. Sie eignet sich zur Steuerung von Wechselstromlasten bis maximal 240 V a.c., 1A. Das Gerät erkennt die Karte automatisch und aktiviert die Funktionen für die Anzeige und die Einstellung der entsprechenden Parameter.

PERFIL

Esta ficha soporta la función de salida prevista como OUT2 en el instrumento 600. Idónea para pilotar las cargas en ca hasta un máximo de 240 Vca, 1 A. La ficha es reconocida de modo automático por el instrumento, que habilita visibilidad y programación de los respectivos parámetros.

PERFIL

Esta placa suporta a função de saída prevista como OUT2 no instrumento 600. É indicada para pilotar cargas de ca até um máximo de 240 V a.c., 1A. A placa é reconhecida automaticamente pelo instrumento, que habilita a visibilidade e configuração dos respectivos parâmetros.

DATI TECNICI

24...240 V a.c. ±10%, 50/60Hz, 1A max
 Snubberless, ammette carico induttivo e resistivo $I^2t=128A^2sec$
 Corrente di perdita 1.5mA max a 200 V a.c.
 Protezione tramite fusibile (EFT-4) 4A, 220Vac NON sostituibile.

TECHNICAL DATA

24...240 V a.c. ±10%, 50/60Hz, 1A max
 Snubberless, admits inductive and resistive load $I^2t=128A^2sec$
 Leakage current 1.5mA max at 200 V a.c.
 Fuse protection (EFT-4) 4A, 220Vac NOT replaceable.

CARACTERISTIQUES TECHNIQUES

24...240 V a.c. ±10%, 50/60Hz, 1A maxi
 'Snubberless', admet la charge inductive et résistive
 $I^2t=128A^2sec$
 Courant de perte 1,5mA maxi à 200 V a.c.
 Protection par fusible (EFT-4) 4A, 220 V a.c. NON remplaçable.

TECHNISCHE DATEN

24...240 V a.c. ±10%, 50/60Hz, 1A max
 Ungedämpft, für induktive und ohmsche Lasten $I^2t=128A^2sec$
 Leckstrom 1,5mA max bei 200 V a.c.
 Schutz durch Sicherung (EFT-4) 4A, 220Vac NICHT austauschbar.

DATOS TÉCNICOS

24...240 V a.c. ±10%, 50/60Hz, 1A máx.
 Snubberless, admite carga inductiva y resistiva $I^2t=128A^2sec$
 Corriente de pérdida 1,5mA máx. a 200 V a.c.
 Protección mediante fusible (EFT-4) 4A, 220 V a.c. NO sustituible.

DADOS TÉCNICOS

24...240 V a.c. ± 10 %, 50/60Hz, 1A máx
 Snubberless, admite carga indutiva e resistiva
 $I^2t=128A^2sec$
 Corrente de fuga 1,5mA máx a 200 V a.c.
 Proteção mediante fusível (EFT-4) 4A, 220 V a.c. NÃO substituível.

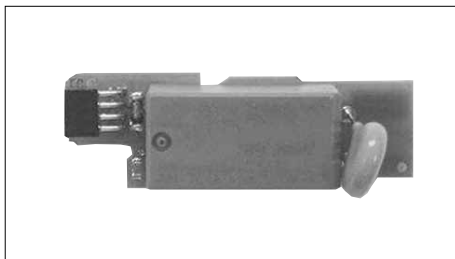

USCITA RELÉ (OUT2)
RELAY OUTPUT (OUT2)
SORTIE RELAIS (OUT2)
RELAISAUSGANG (OUT2)
SALIDA RELÉ (OUT2)
SAÍDA DE RELÉ (OUT2)

PROFILO

Questa scheda supporta la funzione di uscita prevista come OUT2 nello strumento 600. Adatta a pilotare carichi resistivi sino ad un massimo di 5A a 250 V a.c. / 30 V d.c. La schedina è automaticamente riconosciuta dallo strumento che abilita visibilità ed impostazione dei parametri relativi.

PROFILE

This board supports the output function provided as OUT2 on the 600 instrument. Suitable for piloting resistive loads up to a maximum of 5A at 250 V a.c. / 30 V d.c.. The board is automatically recognized by the instrument, which enables display and setting of the parameters involved.

GENERALITES

Cette carte supporte la fonction sortie prévue comme OUT2 dans l'outil 600. Elle est apte à piloter des charges résistives jusqu'à un maximum de 5A à 250 V a.c. / 30 V d.c.. La carte est automatiquement reconnue par l'outil qui habilite la visibilité et la programmation des paramètres appropriés.

BESCHREIBUNG

Diese Karte unterstützt die als OUT2 beim Instrument 600 vorgesehene Ausgangsfunktion. Sie eignet sich zum Steuern von ohmschen Lasten bis maximal 5A bei 250 V a.c. / 30 V d.c.. Das Gerät erkennt die Karte automatisch und aktiviert die Funktionen für die Anzeige und die Einstellung der entsprechenden Parameter.

PERFIL

Esta ficha soporta la función de salida prevista como OUT2 en el instrumento 600. Idónea para pilotar las cargas resistivas hasta un máximo de 5 A a 250 V a.c. / 30 V d.c.. La ficha es reconocida de modo automático por el instrumento, que habilita visibilidad y programación de los respectivos parámetros.

PERFIL

Esta placa suporta a função de saída prevista como OUT2 no instrumento 600. É indicada para pilotar cargas resistivas até um máximo de 5A a 250 V a.c. / 30 V d.c. A placa é reconhecida automaticamente pelo instrumento, que habilita a visibilidade e configuração dos respectivos parâmetros.

DATI TECNICI

Relè a singolo contatto NO

Corrente max 5A a 250 V a.c. / 30 V d.c. $\cos\varphi = 1$

Protezione MOV 275 V 0.25W in parallelo al contatto

È possibile ottenere il relè eccitato all'accensione tramite l'esecuzione del ponticello S1 e la rimozione della resistenza R4.

TECHNISCHE DATEN

Relais mit einem Schließer

Max. Strom 5A bei 250 V a.c. / 30 V d.c. $\cos\varphi = 1$

MOV-Schutz 275 V 0,25W parallel zum Kontakt

Die Erregung des Relais bei der Einschaltung ist möglich, wenn man die Brücke S1 herstellt und den Widerstand R4 entfernt.

TECHNICAL DATA

Single-contact relay NO

Max. current 5A at 250 V a.c. / 30 V d.c. $\cos\varphi = 1$

Protection MOV 275 V 0.25W in parallel to contact

The relay can be energized at power-up by installing jumper S1 and removing resistance R4.

DATOS TÉCNICOS

Relé de contacto único NA

Corriente máx. 5A a 250 V a.c. / 30 V d.c. $\cos\varphi = 1$

Protección MOV 275 V 0,25 W en paralelo con contacto

Es posible obtener la excitación del relé con el encendido mediante aplicación del puente S1 y remoción de la resistencia R4.

CARACTERISTIQUES TECHNIQUES

Relais à contact simple NO

Courant maxi 5A à 250 V a.c. / 30 V d.c. $\cos\varphi = 1$

Protection MOV 275 V 0,25W en parallèle au contact

Il est possible d'obtenir le relais excité lors de la mise sous tension en exécutant le cavalier S1 et en retirant la résistance R4.

DADOS TÉCNICOS

Relé com contato único NA

Corrente máx 5A a 250 V a.c. / 30 V d.c. $\cos\varphi = 1$

Proteção MOV 275 V 0,25W em paralelo no contato

É possível ter o relé excitado no momento de ligação, construindo a ponte S1 e removendo a resistência R4.

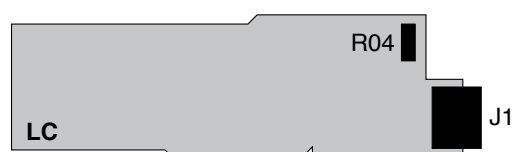
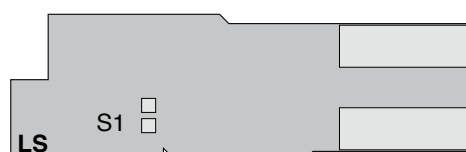

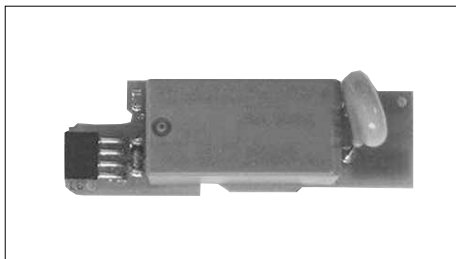

USCITA RELÉ (OUT3)
RELAY OUTPUT (OUT3)
SORTIE RELAIS (OUT3)
RELAISAUSGANG (OUT3)
SALIDA RELÉ (OUT3)
SAÍDA DE RELÉ (OUT3)

PROFILO

Questa scheda supporta la funzione di uscita prevista come OUT3 nello strumento 600. Adatta a pilotare carichi resistivi sino ad un massimo di 5A a 250 V a.c. / 30 V d.c. La schedina è automaticamente riconosciuta dallo strumento che abilita visibilità ed impostazione dei parametri relativi.

PROFILE

This board supports the output function provided as OUT3 on the 600 instrument. Suitable for piloting resistive loads up to a maximum of 5A at 250 V a.c. / 30 V d.c. The board is automatically recognized by the instrument, which enables display and setting of the parameters involved.

GENERALITES

Cette carte supporte la fonction sortie prévue comme OUT3 dans l'outil 600. Elle est apte à piloter des charges résistives jusqu'à un maximum de 5A à 250 V a.c. / 30 V d.c. La carte est automatiquement reconnue par l'outil qui habilite la visibilité et la programmation des paramètres appropriés.

BESCHREIBUNG

Diese Karte unterstützt die als OUT3 beim Instrument 600 vorgesehene Ausgangsfunktion. Sie eignet sich zum Steuern von ohmschen Lasten bis maximal 5A bei 250 V a.c. / 30 V d.c. Das Gerät erkennt die Karte automatisch und aktiviert die Funktionen für die Anzeige und die Einstellung der entsprechenden Parameter.

PERFIL

Esta ficha soporta la función de salida prevista como OUT3 en el instrumento 600. Idónea para pilotar las cargas resistivas hasta un máximo de 5 A a 250 V a.c. / 30 V d.c. La ficha es reconocida de modo automático por el instrumento, que habilita visibilidad y programación de los respectivos parámetros.

PERFIL

Esta placa suporta a função de saída prevista como OUT3 no instrumento 600. É indicada para pilotar cargas resistivas até um máximo de 5A a 250 V a.c. / 30 V d.c. A placa é reconhecida automaticamente pelo instrumento, que habilita a visibilidade e configuração dos respectivos parâmetros.

DATI TECNICI

Relè a singolo contatto NO
Corrente max 5A a 250 V a.c. / 30 V d.c. $\cos\varphi = 1$
Protezione MOV 275 V 0.25W in parallelo al contatto
È possibile ottenere il relè eccitato all'accensione tramite l'esecuzione del ponticello S1 e la rimozione della resistenza R4.

TECHNICAL DATA

Single-contact relay NO
Max. current 5A at 250 V a.c. / 30 V d.c. $\cos\varphi = 1$
Protection MOV 275 V 0.25W in parallel to contact
The relay can be energized at power-up by installing jumper S1 and removing resistance R4.

CARACTERISTIQUES TECHNIQUES

Relais à contact simple NO
Courant maxi 5A à 250 V a.c. / 30 V d.c. $\cos\varphi = 1$
Protection MOV 275 V 0,25W en parallèle au contact
Il est possible d'obtenir le relais excité lors de la mise sous tension en exécutant le cavalier S1 et en retirant la résistance R4.

TECHNISCHE DATEN

Relais mit einem Schließer
Max. Strom 5A bei 250 V a.c. / 30 V d.c. $\cos\varphi = 1$
MOV-Schutz 275 V 0,25W parallel zum Kontakt
Die Erregung des Relais bei der Einschaltung ist möglich, wenn man die Brücke S1 herstellt und den Widerstand R4 entfernt.

DATOS TÉCNICOS

Relé de contacto único NA
Corriente máx. 5A a 250 V a.c. / 30 V d.c. $\cos\varphi = 1$
Protección MOV 275 V 0,25 W en paralelo con contacto
Es posible obtener la excitación del relé con el encendido mediante aplicación del puente S1 y remoción de la resistencia R4.

DADOS TÉCNICOS

Relé com contato único NA
Corrente máx 5A a 250 V a.c. / 30 V d.c. $\cos\varphi = 1$
Proteção MOV 275 V 0,25W em paralelo no contato
É possível ter o relé excitado no momento de ligação, construindo a ponte S1 e removendo a resistência R4.

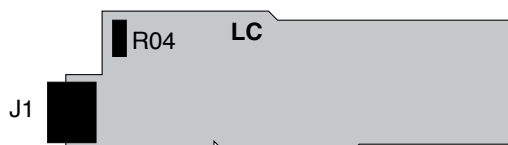

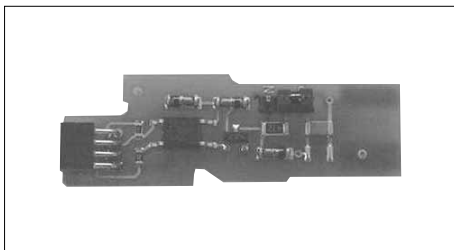

INGRESSO DIGITALE (OUT3)
DIGITAL INPUT (OUT3)
ENTREE LOGIQUE(OUT3)
DIGITALEINGANG (OUT3)
ENTRADA DIGITAL (OUT3)
ENTRADA DIGITAL (OUT3)

PROFILO

Questa scheda supporta la funzione di ingresso logico come alternativa ad OUT3 nello strumento 600. Comando da contatto pulito o da tensione 24 V. La schedina è automaticamente riconosciuta dallo strumento che abilita visibilità ed impostazione dei parametri relativi.

PROFILE

This board supports the logic input function as alternative to OUT3 on the 600 instrument. Command from clean contact of 24 V. The board is automatically recognized by the instrument, which enables display and setting of the parameters involved.

GENERALITES

Cette carte supporte la fonction entrée logique en tant qu'alternative à OUT3 dans l'outil 600. Commande par contact propre ou tension 24 V. La carte est automatiquement reconnue par l'outil qui habilite la visibilité et la programmation des paramètres appropriés.

BESCHREIBUNG

Diese Karte unterstützt die Logikeingang-Funktion als Alternative zum OUT3 beim Gerät 600. Steuerung von potentialfreiem Kontakt oder mit Spannung 24 V. Das Gerät erkennt die Karte automatisch und aktiviert die Funktionen für die Anzeige und die Einstellung der entsprechenden Parameter.

PERFIL

Esta ficha soporta la función de entrada lógica como alternativa a OUT3 en el instrumento 600. Mando de contacto limpio o de tensión 24 V. La ficha es reconocida de modo automático por el instrumento, que habilita visibilidad y programación de los respectivos parámetros.

PERFIL

Esta placa suporta a função de entrada lógica como alternativa de OUT3 no instrumento 600. Comando proveniente de contato limpo ou de tensão de 24 V. A placa é reconhecida automaticamente pelo instrumento, que habilita a visibilidade e configuração dos respectivos parâmetros.

DATI TECNICI

Ingresso da contatto libero da tensione o 24 V d.c. / 5mA
 L'ingresso 24 V è isolato a 1500 V. La schedina in versione standard è configurata per ingresso 24 V / 5mA. È possibile configurare l'ingresso per contatto libero da tensione tramite jumper.

Tipo di ingresso	Jumper
da contatto	S1N,S2N
24 V	S1P,S2P

TECHNICAL DATA

Input from voltage-free contact or 24 V d.c./5mA.
 The 24 V input is isolated 1500 V. The standard card is configured for the 24 V / 5 mA input. The input can be configured voltage-free contact by means of jumper.

Input type	Jumper
from contact	S1N,S2N
24 V	S1P,S2P

CARACTERISTIQUES TECHNIQUES

Entrée par contact exempt de tension ou 24 V d.c. / 5mA
 L'entrée 24 V est isolée 1500 V. La carte en version standard est configurée pour l'entrée 24 V / 5 mA. Il est possible de configurer l'entrée pour contact exempt de tension par le biais d'un cavalier.

Type d'entrée	Cavalier
par contact	S1N,S2N
24 V	S1P,S2P

TECHNISCHE DATEN

Eingang von potentialfreiem Kontakt oder 24 V d.c./5mA.
 Der 24 V-Eingang ist isoliert bis 1500 V. In der Standardausführung ist die Karte für ein Eingangssignal 24 V / 5 mA konfiguriert. Mit einem Jumper kann man den Eingang für einen potentialfreien Kontakt konfigurieren.

Eingangstyp	Jumper
von Kontakt	S1N,S2N
24 V	S1P,S2P

DATOS TÉCNICOS

Entrada de contacto libre de tensión o 24 V d.c./5 mA.
 La entrada 24 V está aislada 1500 V. La ficha en versión estándar está configurada para entrada 24 V/5 mA.
 Es posible configurar la entrada para contacto libre de tensión mediante jumper.

Tipo de entrada	Jumper
desde contacto	S1N,S2N
24 V	S1P,S2P

DADOS TÉCNICOS

Entrada de contato livre de tensão ou 24 V d.c. / 5mA
 A entrada de 24 V está isolada 1500 V. A placa na versão padrão está configurada para entrada de 24 V / 5 mA. É possível configurar a entrada para contato livre de tensão mediante ponte (jumper).

Tipo de entrada	Jumper
de contato	S1N,S2N
24 V	S1P,S2P

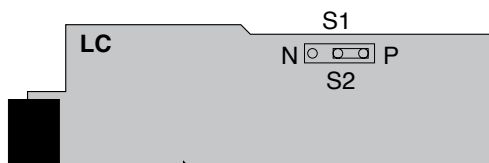

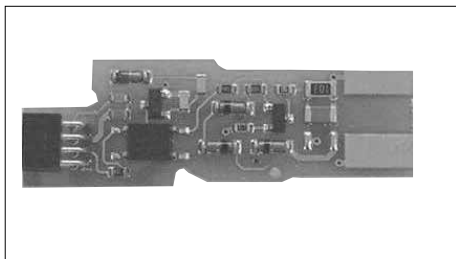

USCITA LOGICA (OUT3)
LOGIC OUTPUT (OUT3)
SORTIE LOGIQUE (OUT3)
LOGIKAUSGANG (OUT3)
SALIDA LÓGICA (OUT3)
SAÍDA LÓGICA (OUT3)

PROFILO

Questa scheda supporta la funzione di uscita prevista come OUT3 nello strumento 600.

Adatta a pilotare ingressi logici, applicazione tipica per interfaccia verso interruttori statici (GTS).

La scheda è automaticamente riconosciuta dallo strumento che abilita visibilità ed impostazione dei parametri relativi.

PROFILE

This board supports the output function provided as OUT3 on the 600 instrument.

Suitable for piloting logic inputs, typical application for interface to solid state switches (GTS).

The board is automatically recognized by the instrument, which enables display and setting of the parameters involved.

GENERALITES

Cette carte supporte la fonction sortie prévue comme OUT3 dans l'outil 600.

Elle est apte à piloter des entrées logiques, application typique pour l'interface vers des interrupteurs statiques (GTS).

La carte est automatiquement reconnue par l'outil qui habilite la visibilité et la programmation des paramètres appropriés.

BESCHREIBUNG

Diese Karte unterstützt die als OUT3 beim Instrument 600 vorgesehene Ausgangsfunktion.

Geeignet für die Steuerung von Logikeingängen, typische Anwendung für Schnittstelle zu Halbleiterrelais (GTS).

Das Gerät erkennt die Karte automatisch und aktiviert die Funktionen für die Anzeige und die Einstellung der entsprechenden Parameter.

PERFIL

Esta ficha soporta la función de salida prevista como OUT3 en el instrumento 600.

Idónea para pilotar entradas lógicas, aplicación típica para interfaz hacia interruptores estáticos (GTS).

La ficha es reconocida de modo automático por el instrumento, que habilita visibilidad y programación de los respectivos parámetros.

PERFIL

Esta placa suporta a função de saída prevista como OUT3 no instrumento 600.

É indicada para pilotar entradas lógicas, aplicação típica para interface versus interruptores estáticos (GTS).

A placa é reconhecida automaticamente pelo instrumento, que habilita a visibilidade e configuração dos respectivos parâmetros.

DATI TECNICI

24 V \pm 10% (10V min a 20mA)

Limitazione di corrente a 30mA

È possibile pilotare direttamente gruppi statici GTS singolarmente o in serie per carichi trifase.

TECHNISCHE DATEN

24 V \pm 10% (10V bei a 20mA)

Strombegrenzung auf 30mA

Die Halbleiterrelais GTS können direkt entweder einzeln oder in Reihe für dreiphasige Lasten gesteuert werden.

TECHNICAL DATA

24 V \pm 10 % (10V min at 20 mA)

Current limitation at 30mA

GTS solid state relays can be piloted directly, either individually or in series by three-phase loads.

DATOS TÉCNICOS

24 V \pm 10% (10V mín. a 20mA)

Limitación de corriente a 30 mA

Es posible pilotar directamente grupos estáticos GTS de modo singular o en serie para cargas trifásicas.

CARACTERISTIQUES TECHNIQUES

24 V \pm 10% (10Vmini à 20mA)

Limitation de courant à 30mA

Il est possible de piloter directement des groupes statiques GTS individuellement ou en série, pour des charges triphasées.

DADOS TÉCNICOS

24 V \pm 10% (10V mín a 20mA)

Limitação de corrente a 30 mA

É possível pilotar grupos estáticos, GTS, diretamente, individualmente ou em série, para cargas trifásicas.

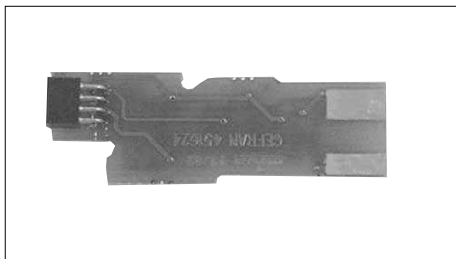

USCITA LOGICA (OUT2)
LOGIC OUTPUT (OUT2)
SORTIE LOGIQUE (OUT2)
LOGIKAUSGANG (OUT2)
SALIDA LÓGICA (OUT2)
SAÍDA LÓGICA (OUT2)

PROFILO

Questa scheda supporta la funzione di uscita prevista come OUT2 nello strumento 600.

Adatta a pilotare ingressi logici, applicazione tipica per interfaccia verso interruttori statici (GTS).

La scheda è automaticamente riconosciuta dallo strumento che abilita visibilità ed impostazione dei parametri relativi.

PROFILE

This board supports the output function provided as OUT2 on the 600 instrument.

Suitable for piloting logic inputs, typical application for interface to solid state switches (GTS).

The board is automatically recognized by the instrument, which enables display and setting of the parameters involved.

GENERALITES

Cette carte supporte la fonction sortie prévue comme OUT2 dans l'outil 600.

Elle est apte à piloter des entrées logiques, application typique pour l'interface vers des interrupteurs statiques (GTS).

La carte est automatiquement reconnue par l'outil qui habilite la visibilité et la programmation des paramètres appropriés.

BESCHREIBUNG

Diese Karte unterstützt die als OUT2 beim Instrument 600 vorgesehene Ausgangsfunktion.

Geeignet für die Steuerung von Logikeingängen, typische Anwendung für Schnittstelle zu Halbleiterrelais (GTS).

Das Gerät erkennt die Karte automatisch und aktiviert die Funktionen für die Anzeige und die Einstellung der entsprechenden Parameter.

PERFIL

Esta ficha soporta la función de salida prevista como OUT3 en el instrumento 600.

Idónea para pilotar entradas lógicas, aplicación típica para interfaz hacia interruptores estáticos (GTS).

La ficha es reconocida de modo automático por el instrumento, que habilita visibilidad y programación de los respectivos parámetros.

PERFIL

Esta placa suporta a função de saída prevista como OUT2 no instrumento 600.

É indicada para pilotar entradas lógicas, aplicação típica para interface versus interruptores estáticos (GTS).

A placa é reconhecida automaticamente pelo instrumento, que habilita a visibilidade e configuração dos respectivos parâmetros.

DATI TECNICI

24 V \pm 10% (10V min a 20mA)

Limitazione di corrente a 30mA

È possibile pilotare direttamente gruppi statici GTS singolarmente o in serie per carichi trifase.

TECHNISCHE DATEN

24 V \pm 10% (10V bei a 20mA)

Strombegrenzung auf 30mA

Die Halbleiterrelais GTS können direkt entweder einzeln oder in Reihe für dreiphasige Lasten gesteuert werden.

TECHNICAL DATA

24 V \pm 10 % (10V min at 20 mA)

Current limitation at 30mA

GTS solid state relays can be piloted directly, either individually or in series by three-phase loads.

DATOS TÉCNICOS

24 V \pm 10 % (10V mín a 20 mA)

Limitación de corriente a 30 mA

Es posible pilotar directamente grupos estáticos GTS de modo singular o en serie para cargas trifásicas.

CARACTERISTIQUES TECHNIQUES

24 V \pm 10% (10Vmini à 20mA)

Limitation de courant à 30mA

Il est possible de piloter directement des groupes statiques GTS individuellement ou en série, pour des charges triphasées.

DADOS TÉCNICOS

24 V \pm 10 % (10V mín a 20 mA)

Limitação de corrente a 30 mA

É possível pilotar grupos estáticos, GTS, diretamente, individualmente ou em série, para cargas trifásicas.

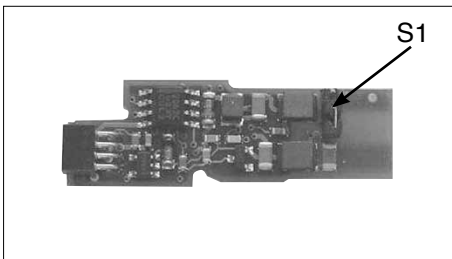

USCITA ANALOGICA (OUT3)
ANALOG OUTPUT (OUT3)
SORTIE ANALOGIQUE (OUT3)
ANALOGAUSGANG (OUT3)
SALIDA ANALÓGICA (OUT3)
SAÍDA ANALÓGICA (OUT3)

PROFILO

Questa scheda supporta la funzione di uscita prevista come OUT3 nello strumento 600. Normalmente utilizzata per la ritrasmissione del valore sonda. La schedina è automaticamente riconosciuta dallo strumento che abilita visibilità ed impostazione dei parametri relativi.

PROFILE

This board supports the output function provided as OUT3 on the 600 instrument. Normally used to retransmit the probe value. The board is automatically recognized by the instrument, which enables display and setting of the parameters involved.

GENERALITES

Cette carte supporte la fonction sortie prévue comme OUT3 dans l'outil 600. Normalement utilisée pour la retransmission de la valeur de sonde La carte est automatiquement reconnue par l'outil qui habilite la visibilité et la programmation des paramètres appropriés.

BESCHREIBUNG

Diese Karte unterstützt die als OUT3 beim Instrument 600 vorgesehene Ausgangsfunktion. Normalerweise für die Weiterleitung des Fühlerwerts verwendet. Das Gerät erkennt die Karte automatisch und aktiviert die Funktionen für die Anzeige und die Einstellung der entsprechenden Parameter.

PERFIL

Esta ficha soporta la función de salida prevista como OUT3 en el instrumento 600. Normalmente utilizada para la retransmisión del valor sonda La ficha es reconocida de modo automático por el instrumento, que habilita visibilidad y programación de los respectivos parámetros

PERFIL

Esta placa suporta a função de saída prevista como OUT3 no instrumento 600. Normalmente, é utilizada para retransmissão do valor da sonda A placa é reconhecida automaticamente pelo instrumento, que habilita a visibilidade e configuração dos respectivos parâmetros.

DATI TECNICI

Uscita standard 0/4...20mA su carico max 500Ω, accuratezza migliore dello 0.2% f.s. Risoluzione 12 bit. E' possibile configurare l'uscita in 0/2...10 V (RLOAD ≥ 250KΩ) tramite jumper che inserisce uno shunt di 500Ω in parallelo all' uscita, max corrente di cortocircuito 20mA. Accuratezza in assenza di calibrazione migliore dell'1% f.s.

Nel caso si desideri un' accuratezza superiore effettuare la calibrazione utente (uscita analogica) come descritto nel manuale d' uso.

Tipo di uscita	Jumper S1
20mA	OFF (aperto) standard
10 V	ON (chiuso)

TECHNISCHE DATEN

Standardausgang 0/4...20mA bei max. Last von 500Ω, Genauigkeit besser als 0,2 % v.Ew. Auflösung 12 Bit. Es ist möglich, den Ausgang 0/2...10 V (RLOAD ≥ 250KΩ) mittels Jumper zu konfigurieren, der einen Nebenwiderstand von 500Ω parallel zum Ausgang zwischenschaltet; max. Kurzschlussstrom 20mA. Genauigkeit ohne Kalibration besser als 1 % v.Ew. Wenn eine höhere Genauigkeit verlangt ist, die kundenspezifische Kalibrierung (Analogausgang) wie in der Bedienungsanleitung beschrieben vornehmen.

Ausgangstyp	Jumper S1
20mA	OFF (Offen) Standard
10 V	ON (Geschlossen)

TECHNICAL DATA

Standard output 0/4...20mA on max. load 500Ω, accuracy better than 0.2 % f.s. Resolution 12 bit.

The 0/2...10 V output (RLOAD ≥ 250KΩ) can be configured by jumper, which inserts a 500Ω shunt in parallel to the output, max. short circuit current 20mA. Accuracy in absence of calibration better than 1% f.s. If greater accuracy is required, perform the user calibration (analog output) as described in the instruction manual.

Output type	Jumper S1
20mA	OFF (open) standard
10 V	(closed)

DATOS TÉCNICOS

Salida estándar 0/4...20mA en carga máx. 500Ω, precisión superior a 0,2 % f.s. Resolución 12 bits. Es posible configurar la salida 0/2...10 V (RLOAD ≥ 250KΩ) mediante jumper que conecta un shunt de 500Ω en paralelo con la salida; corriente máx. de cortocircuito 20mA. Precisión sin calibración superior a 1 % sobre f.s. Si se desea obtener mayor precisión se deberá efectuar la calibración usuario (salida analógica), procediendo de la manera ilustrada en el manual de uso.

Tipo de salida	Jumper S1
20mA	OFF (abierto) estándar
10 V	ON (cerrado)

CARACTERISTIQUES TECHNIQUES

Sortie standard 0/4...20mA sut charge maxi 500Ω, précision supérieure à 0.2 % p.e. Résolution 12 bits. Il est possible de configurer la sortie 0/2...10 V (RLOAD ≥ 250KΩ) par un cavalier qui insère un shunt de 500Ω en parallèle à la sortie, courant maxi de court-circuit 20mA. Précision en l'absence d'étalonnage supérieure à 1 % sur p.e. Pour obtenir une précision plus élevée, effectuer l'étalonnage utilisateur (sortie analogique), comme décrit dans le Manuel Opérateur.

Type de sortie	Cavalier S1
20mA	OFF (ouvert) standard
10 V	ON (fermé)

DADOS TÉCNICOS

Saída padrão 0/4...20mA sobre carga máxima de 500Ω, grau de precisão inferior a 0,2 % f.e. Resolução 12 bit. É possível configurar a saída 0/2...10 V (RLOAD ≥ 250KΩ) mediante ponte que introduz um shunt de 500Ω em paralelo na saída, corrente máx. de curto-circuito 20mA. O grau de precisão na ausência de calibração é inferior a 1 % do f.e. No caso de desejar maior precisão, faça a calibração do usuário (saída analógica) conforme descrito no manual de utilização.

Tipo de saída	Jumper S1
20mA	OFF (aberto) padrão
10 V	ON (fechado)

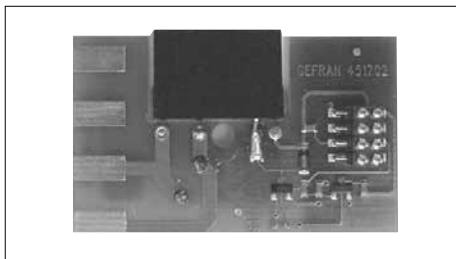

USCITA RELÉ (OUT4)
RELAY OUTPUT (OUT4)
SORTIE RELAIS (OUT4)
RELAISAUSGANG (OUT4)
SALIDA RELÉ (OUT4)
SAÍDA DE RELÉ (OUT4)

PROFILO

Questa scheda supporta la funzione di uscita prevista come OUT4 nello strumento 600. Adatta a pilotare carichi resistivi sino ad un massimo di 5A a 250 V a.c./30 V d.c. La schedina è automaticamente riconosciuta dallo strumento che abilita visibilità ed impostazione dei parametri relativi.

PROFILE

This board supports the output function provided as OUT4 on the 600 instrument. Suitable for piloting resistive loads up to a maximum of 5A at 250 V a.c./30 V d.c. The board is automatically recognized by the instrument, which enables display and setting of the parameters involved.

GENERALITES

Cette carte supporte la fonction sortie prévue comme OUT4 dans l'outil 600. Elle est apte à piloter des charges résistives jusqu'à un maximum de 5A à 250Vca/30Vcc. La carte est automatiquement reconnue par l'outil qui habilite la visibilité et la programmation des paramètres appropriés.

BESCHREIBUNG

Diese Karte unterstützt die als OUT4 beim Instrument 600 vorgesehene Ausgangsfunktion Sie eignet sich zum Steuern von ohmschen Lasten bis maximal 5A bei 250 V a.c./30 V d.c. Das Gerät erkennt die Karte automatisch und aktiviert die Funktionen für die Anzeige und die Einstellung der entsprechenden Parameter.

PERFIL

Esta ficha soporta la función de salida prevista como OUT4 en el instrumento 600. Idónea para pilotar las cargas resistivas hasta un máximo de 5 A a 250 V a.c./30 V d.c. La ficha es reconocida de modo automático por el instrumento, que habilita visibilidad y programación de los respectivos parámetros

PERFIL

Esta placa suporta a função de saída prevista como OUT4 no instrumento 600. É indicada para pilotar cargas resistivas até um máximo de 5A a 250 V a.c./30 V d.c. A placa é reconhecida automaticamente pelo instrumento, que habilita a visibilidade e configuração dos respectivos parâmetros.

DATI TECNICI

Relè a singolo contatto NO
 Corrente max 5A a 250 V a.c./30 V d.c. $\cos\varphi = 1$
 Protezione MOV 275 V 0.25W in parallelo al contatto
 È possibile ottenere il relè eccitato all'accensione tramite l'esecuzione del ponticello S1 e la rimozione della resistenza R4.

TECHNISCHE DATEN

Relais mit einem Schließer
 Max. Strom 5A bei 250 V a.c./30 V d.c. $\cos\varphi = 1$
 MOV-Schutz 275 V 0,25W parallel zum Kontakt
 Die Erregung des Relais bei der Einschaltung ist möglich, wenn man die Brücke S1 herstellt und den Widerstand R4 entfernt.

TECHNICAL DATA

Single-contact relay NO
 Max. current 5A at 250 V a.c./30 V d.c. $\cos\varphi = 1$
 Protection MOV 275 V 0.25W in parallel to contact
 The relay can be energized at power-up by installing jumper S1 and removing resistance R4.

DATOS TÉCNICOS

Relè a singolo contatto NO Relé de contacto único NA
 Corriente máx. 5A a 250 V a.c./30 V d.c. $\cos\varphi = 1$
 Protección MOV 275 V 0,25W en paralelo con contacto
 Es posible obtener la excitación del relé con el encendido mediante aplicación del puente S1 y remoción de la resistencia R4.

CARACTERISTIQUES TECHNIQUES

Relais à contact simple NO
 Courant maxi 5A à 250 V a.c./30 V d.c. $\cos\varphi = 1$
 Protection MOV 275 V 0,25W en parallèle au contact
 Il est possible d'obtenir le relais excité lors de la mise sous tension en exécutant le cavalier S1 et en retirant la résistance R4.

DADOS TÉCNICOS

Relé com contacto único NA
 Corrente máx. 5A a 250 V a.c./30 V d.c. $\cos\varphi = 1$
 Proteção MOV 275 V ,25W em paralelo no contato
 É possível ter o relé excitado no momento de ligação, construindo a ponte S1 e removendo a resistência R4.

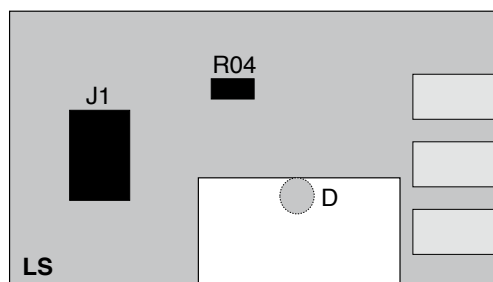
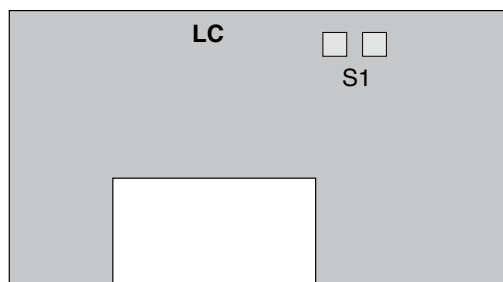

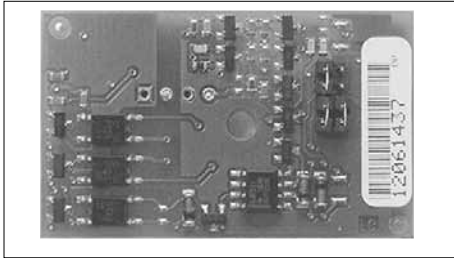

USCITA SERIALE (OUT4)
SERIAL OUTPUT (OUT4)
SORTIE SERIE (OUT4)
SERIELLER AUSGANG (OUT4)
SALIDA SERIE (OUT4)
SAÍDA SERIAL (OUT4)

PROFILO

Questa scheda supporta la funzione di uscita prevista come OUT4 nello strumento 600. Interfaccia seriale standard RS485. La scheda è automaticamente riconosciuta dallo strumento che abilita visibilità ed impostazione dei parametri relativi.

PROFILE

This board supports the output function provided as OUT4 on the 600 instrument. RS485 standard serial interface. The board is automatically recognized by the instrument, which enables display and setting of the parameters involved.

GENERALITES

Cette carte supporte la fonction sortie prévue comme OUT4 dans l'outil 600. Interface série standard RS485. La carte est automatiquement reconnue par l'outil qui habilite la visibilité et la programmation des paramètres appropriés.

BESCHREIBUNG

Diese Karte unterstützt die als OUT4 beim Instrument 600 vorgesehene Ausgangsfunktion. Serielle Standardschnittstelle RS485. Das Gerät erkennt die Karte automatisch und aktiviert die Funktionen für die Anzeige und die Einstellung der entsprechenden Parameter.

PERFIL

Esta ficha soporta la función de salida prevista como OUT4 en el instrumento 600. Interfaz serie estándar RS485. La ficha es reconocida de modo automático por el instrumento, que habilita visibilidad y programación de los respectivos parámetros

PERFIL

Esta placa suporta a função de saída prevista como OUT4 no instrumento 600. Interface serial padrão RS485. A placa é reconhecida automaticamente pelo instrumento, que habilita a visibilidade e configuração dos respectivos parâmetros.

DATI TECNICI

Standard RS485. Isolamento 1500 V. Baudrate 19200 max
 Collegamento 2 o 4 fili per protocollo MODBUS o CENCAL
 Tramite jumper è possibile effettuare il collegamento parallelo tra Tx ed Rx nel caso di collegamento 2 fili con protocollo MODBUS.

TECHNISCHE DATEN

Standard RS485. Isolationsspannung 1500 V. Baudrate 19200 max. Anschluss 2- oder 4-Leiter für Protokoll MODBUS oder CENCAL. Mit einem Jumper ist der parallele Anschluss zwischen Tx und Rx bei 2-Leiter-Anschluss für Protokoll MODBUS möglich.

TECHNICAL DATA

Standard RS485. Isolation 1500 V. Baudrate 19200 max
 2 or 4 wire connection for MODBUS or CENCAL protocol.
 A parallel connection between Tx and Rx can be made in the case of 2-wire connection with MODBUS protocol.

DATOS TÉCNICOS

Estándar RS485. Isolamiento 1500 V.
 Baudrate 19200 máx. Conexión 2 ó 4 hilos para protocolo MODBUS o CENCAL
 Mediante jumper es posible efectuar la conexión paralela entre tra Tx y Rx en caso de conexión 2 hilos con protocolo MODBUS.

CARACTERISTIQUES TECHNIQUES

Standard RS485. Isolement 1500 V. Baudrate 19200 maxi
 Connexion 2 ou 4 fils pour protocoles MODBUS ou CENCAL
 Par le biais d'un cavalier, il est possible d'effectuer la connexion parallèle entre Tx et Rx en cas de connexion 2 fils avec protocole MODBUS.

DADOS TÉCNICOS

Padrão RS485. Isolamento 1500 V. Baudrate 19200 máx.
 Ligação de 2 ou 4 fios para protocolo MODBUS ou CENCAL
 Mediante jumper é possível fazer a ligação de Tx e Rx em paralelo em caso de ligação 2 fios com protocolo MODBUS.

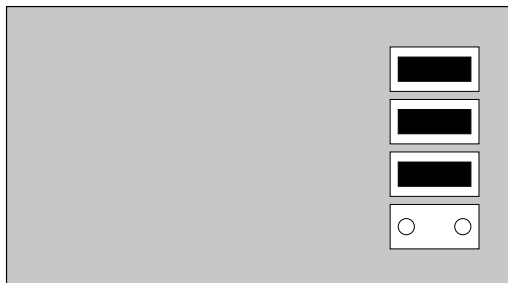

RS485 (2 fili)
 RS485 (2 wire)
 RS485 (2 fils)

RS485 (2-Leiter)
 RS485 (2 hilos)
 RS485 (2 fios)

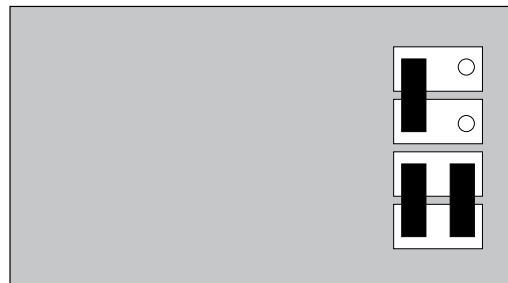

Collegamento 4 fili
 Connection 4 wire
 Connexion 4 fils

Anschluss 4-Leiter
 Conexión 4 hilos
 Ligação 4 fios

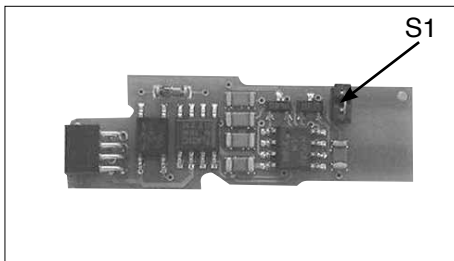

USCITA CONTINUA (OUT3)
CONTINUOUS OUTPUT (OUT3)
SORTIE CONTINUE (OUT3)
STETIGER AUSGANG (OUT3)
SALIDA CONTINUA (OUT3)
SAÍDA CONTÍNUA (OUT3)

PROFILO

Questa scheda supporta la funzione di uscita prevista come OUT3 nello strumento 600. Normalmente utilizzata come uscita di regolazione. La schedina è automaticamente riconosciuta dallo strumento che abilita visibilità ed impostazione dei parametri relativi.

PROFILE

This board supports the output function provided as OUT3 on the 600 instrument. Normally used as control output. The board is automatically recognized by the instrument, which enables display and setting of the parameters involved.

GENERALITES

Cette carte supporte la fonction sortie prévue comme OUT3 dans l'outil 600. Normalement utilisée en tant que sortie de régulation. La carte est automatiquement reconnue par l'outil qui habilite la visibilité et la programmation des paramètres appropriés.

BESCHREIBUNG

Diese Karte unterstützt die als OUT3 beim Instrument 600 vorgesehene Ausgangsfunktion. Normalerweise als Regelausgang verwendet. Das Gerät erkennt die Karte automatisch und aktiviert die Funktionen für die Anzeige und die Einstellung der entsprechenden Parameter.

PERFIL

Esta ficha soporta la función de salida prevista como OUT3 en el instrumento 600. Normalmente utilizada como salida de regulación. La ficha es reconocida de modo automático por el instrumento, que habilita visibilidad y programación de los respectivos parámetros.

PERFIL

Esta placa suporta a função de saída prevista como OUT3 no instrumento 600. Normalmente é utilizada como saída de controle. A placa é reconhecida automaticamente pelo instrumento, que habilita a visibilidade e configuração dos respectivos parâmetros.

DATI TECNICI

Uscita standard 0/2...10 V, Rout = 500Ω (RLOAD ≥ 250KΩ), max corrente di cortocircuito 20mA, accuratezza migliore 2% f.s. Risoluzione 7 bit (PWM). È possibile configurare l'uscita in 0/4...20mA (RLOAD ≤ 500Ω) tramite jumper che toglie uno shunt di 500Ω in parallelo all'uscita.

Tipo di uscita	Jumper S1
20mA	OFF (aperto)
10 V	ON (chiuso) standard

TECHNICAL DATA

Standard output 0/2...10 V, Rout = 500Ω (RLOAD ≥ 250KΩ), max. short circuit current 20mA, accuracy better than 2% f.s. Resolution 7 bit (PWM). The 0/4...20mA (RLOAD ≤ 500Ω) output can be configured by jumper, which inserts a 500Ω shunt in parallel to the output.

Output type	Jumper S1
20mA	OFF (open)
10 V	ON (closed) standard

CARACTERISTIQUES TECHNIQUES

Sortie standard 0/2...10 V, Rout = 500Ω (RLOAD ≥ 250KΩ), courant maxi de court-circuit 20mA, précision supérieure à 2% p.e. Résolution 7 bits (PWM). Il est possible de configurer la sortie 0/4...20mA (RLOAD ≤ 500Ω) par un cavalier qui insère un shunt de 500Ω en parallèle à la sortie.

Type de sortie	Cavalier S1
20mA	OFF (ouvert)
10 V	ON (fermé) standard

TECHNISCHE DATEN

Standardausgang 0/2...10 V, Rout = 500Ω (RLOAD ≥ 250KΩ), max. Kurzschlussstrom 20mA, Genauigkeit besser als 2% v.Ew. Auflösung 7 Bit (PWM). Es ist möglich, den Ausgang 0/4...20mA (RLOAD ≤ 500Ω) mittels Jumper zu konfigurieren, der einen Nebenwiderstand von 500Ω parallel zum Ausgang zwischenschaltet.

Ausgangstyp	Jumper S1
20mA	OFF (Offen)
10 V	ON (Geschlossen) Standard

DATOS TÉCNICOS

Salida estándar 0/2...10 V, Rout = 500Ω (RLOAD ≥ 250KΩ), corriente máx. de cortocircuito 20mA, precisión superior a 2% f.s. Resolución 7 bit (PWM). Es posible configurar la salida 0/4...20mA (RLOAD ≤ 500Ω) mediante jumper que conecta un shunt de 500Ω en paralelo con la salida.

Tipo de salida	Jumper S1
20mA	OFF (abierto)
10 V	ON (cerrado) estándar

DADOS TÉCNICOS

Saída padrão 0/2...10 V, Rout = 500Ω, corrente máx. de curto-circuito 20mA (RLOAD ≤ 500Ω), grau de precisão inferior a 2% f.e. Resolução 7 bit (PWM). É possível configurar a saída 0/4...20mA (RLOAD ≤ 500Ω) mediante ponte que introduz um shunt de 500Ω em paralelo na saída.

Tipo de saída	Jumper S1
20mA	OFF (aberto)
10 V	ON (fechado) padrão

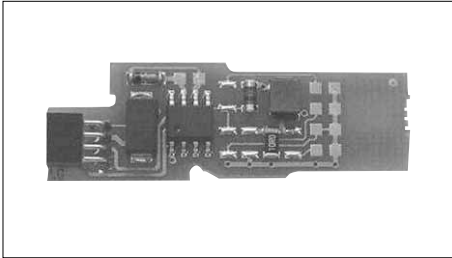

INGRESSO TA (OUT3)
CT INPUT (OUT3)
ENTREE TA (OUT3)
STROMWANDLER-EINGANG (OUT3)
ENTRADA TA (OUT3)
ENTRADA TA (OUT3)

PROFILO

Questa scheda supporta la funzione di ingresso da trasformatore amperometrico come alternativa ad OUT3 nello strumento 600. La scheda è automaticamente riconosciuta dallo strumento che abilita visibilità ed impostazione dei parametri relativi.

PROFILE

This board supports the current transformer input function as alternative to OUT3 on the 600 instrument. The board is automatically recognized by the instrument, which enables display and setting of the parameters involved.

GENERALITES

Cette carte supporte la fonction entrée depuis le transformateur ampèremétrique en tant qu'alternative à OUT3 dans l'outil 600. La carte est automatiquement reconnue par l'outil qui habilite la visibilité et la programmation des paramètres appropriés.

BESCHREIBUNG

Die Karte unterstützt die Stromwandlereingangsfunktion als Alternative zum OUT3 des Geräts 600. Das Gerät erkennt die Karte automatisch und aktiviert die Funktionen für die Anzeige und die Einstellung der entsprechenden Parameter.

PERFIL

Esta ficha soporta la función de entrada desde transformador amperimétrico como alternativa a OUT3 en el instrumento 600. La ficha es reconocida de modo automático por el instrumento, que habilita visibilidad y programación de los respectivos parámetros.

PERFIL

Esta placa suporta a função de entrada de transformador amperométrico como alternativa de OUT3 no instrumento 600. A placa é reconhecida automaticamente pelo instrumento, que habilita a visibilidade e configuração dos respectivos parâmetros.

DATI TECNICI

Ingresso 0...50mAac, 50/60Hz.
Resistenza ingresso: 10Ω
Accuratezza migliore dell'1% f.s. in assenza della calibrazione utente (ingresso 2 - custom TA) come descritto nel manuale d'uso.

TECHNISCHE DATEN

Eingang 0...50 mAac 50/60 Hz.
Eingangswiderstand: 10Ω
Genauigkeit besser als 1% v.Ew. ohne kundenspezifische Kalibration (Eingang 2 - kundenspezifischer Stromwandler und wie in der Bedienungsanleitung beschrieben).

TECHNICAL DATA

Input 0...50mAac, 50/60Hz.
Input resistance: 10Ω
Accuracy better than 1% f.s. in absence of user calibration (input 2 - custom CT and as described in the instruction manual).

DATOS TÉCNICOS

Entrada 0...50mAca, 50/60Hz. Resistencia entrada: 10Ω
Precisión superior al 1 % f.s. si no se ejecuta la calibración usuario (entrada 2 - personalizada TA y de la manera ilustrada en el manual de uso).

CARACTERISTIQUES TECHNIQUES

Entrée 0...50mAca, 50/60Hz.
Résistance entrée: 10Ω
Précision supérieure à 1% p.e. en l'absence de l'étalonnage utilisateur (entrée 2 - sur mesure TA et comme décrit dans le Manuel Opérateur).

DADOS TÉCNICOS

Entrada 0...50mAca, 50/60Hz.
Resistência de entrada: 10Ω
Grau de precisão inferior a 1% do f.e. na ausência de calibração do usuário (entrada 2 - personalizada TA e como descrito no manual do usuário).



USCITA DIGITALE ISOLATA (OUT2)
DIGITAL INSULATED OUTPUT (OUT2)
SORTIE NUMERIQUE ISOLEE (OUT2)
ISOLIERTER DIGITALAUSGANG (OUT2)
SALIDA DIGITAL AISLADA (OUT2)
SAÍDA DIGITAL ISOLADA (OUT2)

PROFILO

Questa scheda supporta la funzione di uscita prevista come OUT2 nello strumento 600.

Adatta a pilotare ingressi di PLC e carichi ac/dc.

La schedina è automaticamente riconosciuta dallo strumento che abilita visibilità ed impostazione dei parametri relativi.

PROFILE

This board supports the output function provided as OUT2 on the 600 instrument.

Suitable to drive PLC inputs and ac/dc loads.

The board is automatically recognized by the instrument, which enables display and setting of the parameters involved.

GENERALITES

Cette carte supporte la fonction sortie prévue comme OUT2 dans l'outil 600.

Apte à piloter les entrées de PLC et les charges CA/CC .

La carte est automatiquement reconnue par l'outil qui habilite la visibilité et la programmation des paramètres appropriés.

BESCHREIBUNG

Diese Karte unterstützt die als OUT2 beim Instrument 600 vorgesehene Ausgangsfunktion.

Zum Ansteuern von SPS-Eingängen und Wechselstrom- und Gleichstromlasten.

Das Gerät erkennt die Karte automatisch und aktiviert die Funktionen für die Anzeige und die Einstellung der entsprechenden Parameter.

PERFIL

Esta ficha soporta la función de salida prevista como OUT3 en el instrumento 600.

Adecuada para pilotar entradas de PLC y cargas ca/cc.

La ficha es reconocida de modo automático por el instrumento, que habilita visibilidad y programación de los respectivos parámetros.

PERFIL

Esta placa suporta a função de saída prevista como OUT2 no instrumento 600.

Indicada para pilotar entradas de PLC e cargas de ca/cc .

A placa é reconhecida automaticamente pelo instrumento, que habilita a visibilidade e configuração dos respectivos parâmetros.

DATI TECNICI

uscita MOS optoisolata 1500 V_{RMS}

equivalente ad un contatto NO

V_{max} 40 V a.c./V d.c. I_{MAX} 100mA

Resistenza ON max 0,8Ω

TECHNISCHE DATEN

MOS-Ausgang, optoisoliert, 1500 V_{RMS}

equivalent to NO contact

V_{max} 40 V a.c./V d.c., I_{max} 100mA

Max. Widerstand ON 0,8Ω.

TECHNICAL DATA

Optoinsulated MOS output, 1500 V_{RMS}

equivalent to NO contact

V_{max} 40 V a.c./V d.c. I_{MAX} 100mA

Load ON max 0,8Ω

DATOS TÉCNICOS

Salida MOS optoaislada 1500 V_{RMS}

equivalent to NO contact

V_{max} 40 V a.c./V d.c. I_{MAX} 100mA

Resistencia máx ON 0,8Ω.

CARACTERISTIQUES TECHNIQUES

Sortie MOS opto-isolée 1500 V_{RMS}

equivalent to NO contact

V_{max} 40 V a.c./V d.c., I_{MAX} 100mA

Résistance maximale ON 0,8Ω.

DADOS TÉCNICOS

Saída MOS optoisolada 1500 V_{RMS}

equivalent to NO contact

V_{max} 40 V a.c./V d.c. I_{MAX} 100mA

Resistência máx ON 0,8Ω.

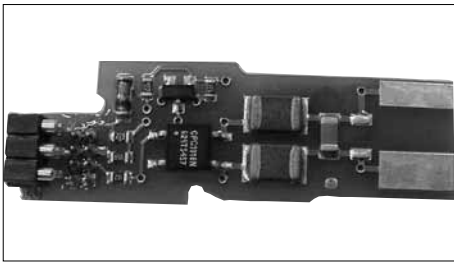

USCITA DIGITALE ISOLATA (OUT3)
DIGITAL INSULATED OUTPUT (OUT3)
SORTIE NUMERIQUE ISOLEE (OUT3)
ISOLIERTER DIGITALAUSGANG (OUT3)
SALIDA DIGITAL AISLADA (OUT3)
SAÍDA DIGITAL ISOLADA (OUT3)

PROFILO

Questa scheda supporta la funzione di uscita prevista come OUT3 nello strumento 600.
Adatta a pilotare ingressi di PLC e carichi ac/dc.

La schedina è automaticamente riconosciuta dallo strumento che abilita visibilità ed impostazione dei parametri relativi.

PROFILE

This board supports the output function provided as OUT3 on the 600 instrument.

Suitable to drive PLC inputs and ac/dc loads.

The board is automatically recognized by the instrument, which enables display and setting of the parameters involved.

GENERALITES

Cette carte supporte la fonction sortie prévue comme OUT3 dans l'outil 600.

Apte à piloter les entrées de PLC et les charges CA/CC .

La carte est automatiquement reconnue par l'outil qui habilite la visibilité et la programmation des paramètres appropriés.

BESCHREIBUNG

Diese Karte unterstützt die als OUT3 beim Instrument 600 vorgesehene Ausgangsfunktion.

Zum Ansteuern von SPS-Eingängen und Wechselstrom- und Gleichstromlasten.

Das Gerät erkennt die Karte automatisch und aktiviert die Funktionen für die Anzeige und die Einstellung der entsprechenden Parameter.

PERFIL

Esta ficha soporta la función de salida prevista como OUT3 en el instrumento 600.

Adecuada para pilotear entradas de PLC y cargas ca/cc.

La ficha es reconocida de modo automático por el instrumento, que habilita visibilidad y programación de los respectivos parámetros.

PERFIL

Esta placa suporta a função de saída prevista como OUT3 no instrumento 600.

Indicada para pilotar entradas de PLC e cargas de ca/cc .

A placa é reconhecida automaticamente pelo instrumento, que habilita a visibilidade e configuração dos respectivos parâmetros.

DATI TECNICI

uscita MOS optoisolata 1500 V RMS

equivalente ad un contatto NO

Vmax 40 V a.c./V d.c. I_{MAX} 100mA

Resistenza ON max 0,8Ω

TECHNISCHE DATEN

MOS-Ausgang, optoisoliert, 1500 V RMS

equivalent to NO contact

Vmax 40 V a.c./V d.c., I_{max} 100mA

Max. Widerstand ON 0,8Ω.

TECHNICAL DATA

Optoinsulated MOS output, 1500 V RMS

equivalent to NO contact

Vmax 40 V a.c./V d.c. I_{MAX} 100mA

Load ON max 0,8Ω

DATOS TÉCNICOS

Salida MOS optoaislada 1500 V RMS

equivalent to NO contact

Vmax 40 V a.c./V d.c. I_{MAX} 100mA

Resistencia máx ON 0,8Ω.

CARACTERISTIQUES TECHNIQUES

Sortie MOS opto-isolée 1500 V RMS

equivalent to NO contact

Vmax 40 V a.c./V d.c., I_{max} 100mA

Résistance maximale ON 0,8Ω.

DADOS TÉCNICOS

Saída MOS optoisolada 1500 V RMS

equivalent to NO contact

Vmax 40 V a.c./V d.c. I_{MAX} 100mA

Resistência máx ON 0,8Ω.