



INSTALLATION and OPERATION MANUAL

SOFTWARE VERSION **3.2x** (includes R77 and R98 versions)
code **81642H** / Edition **15 - 11-2013**

1 • INSTALLATION

• Dimensions and cut-out; panel mounting

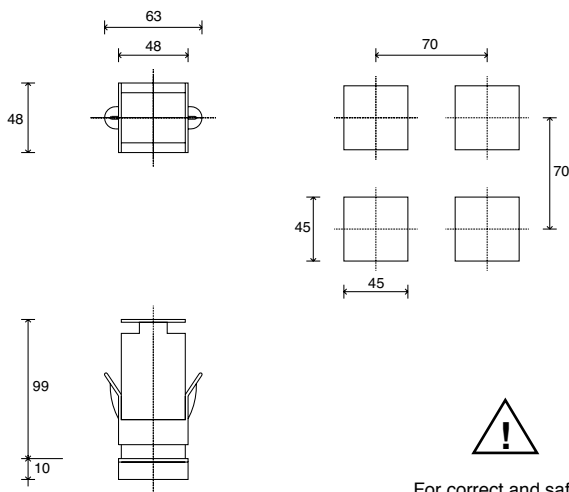

For correct and safe installation, observe the warnings contained in this manual.

Panel mounting:

Fix the device with the bracket provided before making any electrical connections.
To mount two or more devices side by side, use the cut-out dimensions shown above.

CE MARKING: The instrument conforms to the European Directives 2004/108/CE and 2006/95/CE with reference to the generic standards: **EN 61000-6-2** (immunity in industrial environment) **EN 61000-6-3** (emission in residential environment) **EN 61010-1** (safety)

MAINTENANCE: Repairs must be done out only by trained and specialized personnel. Cut power to the device before accessing internal parts.

Do not clean the case with hydrocarbon-based solvents (Petrol, Trichlorethylene, etc.). Use of these solvents can reduce the mechanical reliability of the device. Use a cloth dampened in ethyl alcohol or water to clean the external plastic case.

SERVICE: GEF 40T 48 has a service department. The warranty excludes defects caused by any use not conforming to these instruction.

EMC conformity has been tested with the following connections

FUNCTION	CABLE TYPE	LENGTH USED
TC input probe	0,8 mm ² compensated	5 mt
"PT100" input probe	1 mm ²	3 mt
Power supply cable	1 mm ²	1 mt
Relay output wires	1 mm ²	3,5 mt
Serial connection wire	0,35 mm ²	3,5 mt

2 • TECHNICAL SPECIFICATIONS

<i>Display</i>	4 digit red digit height 10mm
<i>Keys</i>	3 mechanical keys (Raise, Lower, F)
<i>Accuracy</i>	0.2% f.s. at 25°C ambient temperature, ts = 120msec
<i>Resolution</i> (function of settable sample time)	120msec, >14bit-16000 points 60msec, >14bit-16000 points (only for linear inputs) 30msec, >13bit - 8000 points (only for linear inputs) 15msec, >12bit - 4000 points (only for linear inputs)
<i>Main input</i>	TC, RTD, PTC, NTC 60mV, 1V Ri ≥ 1MΩ, 5V, 10V, Ri ≥ 10KΩ 20mA, Ri = 50Ω. adjustable digital filter
<i>TC Type</i> <i>Thermocouples (ITS90)</i>	J, K, R, S, T, B, E, N (IEC 584-1, CEI EN 60584-1, 60584-2) L GOST, U, G, D, C. Custom linearization available on request
<i>Cold junction error</i>	0,1° / °C
<i>RTD Type (scale configurable within indicated range, with or without decimal point, ITS90)</i>	DIN 43760 (PT100), JPT100
<i>Max. RTD line resistance</i>	20Ω
<i>PTC Type/ NTC Type</i>	990Ω, 25°C / 1KΩ, 25°C
<i>Max. non-linearity error</i>	See tP parameter
<i>°C / °F selection</i>	Faceplate configurable
<i>Linear scale ranges</i>	-1999...9999 Configurable decimal point position, possible 32 segment linearization
<i>Logic input</i>	24V, 5mA (Ri = 47KΩ) 1500 V isolation or voltage-free contact
<i>Function of logic input</i>	configurable to reset memory latch, hold, flash, zero, select max./ min. peak, peak-peak value
<i>Alarms (Trip points)</i>	Maximum of three configurable alarms: absolute, deviation, symmetrical deviation. Adjustable hysteresis
<i>Alarm masking</i>	- exclude on power-up - latch reset from key and/or external contact - insert delay filter (DON, DBI, DOF, DPO) - set minimum intervention time
<i>Relay contact</i>	NO (NC) 5A, 250Vac / 30Vdc
<i>Logic output</i>	24Vdc, Rout = 500Ω (10V/20mA) limitation to 30mA
<i>Triac output</i>	20...240Vac ±10%, 1A max. Snubberless, inductive and resistive load I ² t = 128A ² S
<i>Fault settings</i>	Alarm states can be configured in probe fault condition
<i>(option) Transmitter / Sensor</i>	24V ±10%, 50mA
<i>Power Supply</i>	15V for transmitter, max. 50mA 1,2V for potentiometer > 100Ω
<i>(option) Analog retransmission</i>	10V / 20mA on max. 500Ω resolution 12 bits
<i>Power supply (switching)</i>	(standard) 100...240Vac/dc ±10%, 50/60Hz, 8VA (optional) 11...27Vac/dc ±10%, 50/60Hz, 8VA
<i>Faceplate protection</i>	IP65
<i>Working / Storage temperatures</i>	0...50°C / -20...70°C
<i>Relative humidity</i>	20...85% Ur non-condensing
<i>Environmental conditions of use</i>	for internal use only, altitude up to 2000m
<i>Installation</i>	Panel mounting, extractable from front
<i>Weight</i>	160 g

3 • DESCRIPTION OF FACEPLATE

Indication of output states:
OUT 1 (Alarm 1); OUT 2 (Alarm 2);
OUT 3 (Alarm 3) OUT 4 (Alarm 4)

"Raise" and "Lower" keys:

These keys are used for any operation that requires a numerical parameter to be raised or lowered • The speed of change is proportional to the time the key is pressed • The operation is not cyclic: once the maximum (minimum) limit is reached, there will be no further increase (decrease) of the value, even if the key remains pressed. The keys can be configured to perform reset, hold, display of the peak value, etc. as determined by the 't.U.' and 't.d.' parameters on the 'In' menu



PV Display: Indication of process variable
Indication of 'HI' or 'Lo' out of range
•• Indication of open circuit (br) or short circuit (Er)
•• Display of configuration and calibration messages

Label with engineering units

Function key:

Gives access to different configuration stages ••
Confirms any parameter changes

4 • CONNECTIONS

• Outputs / Logic input

Generic-user configurable outputs

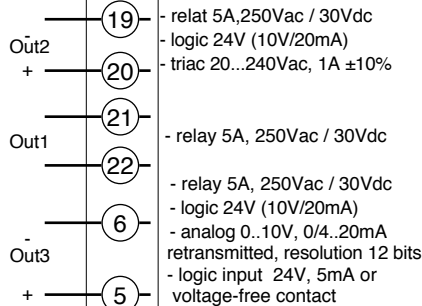

• Power supply

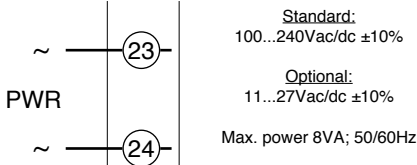

• Serial line / output 4

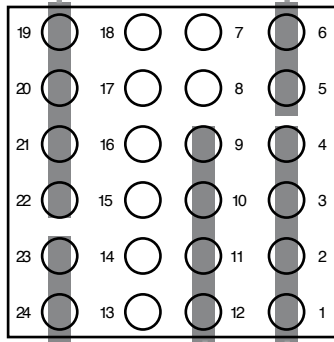
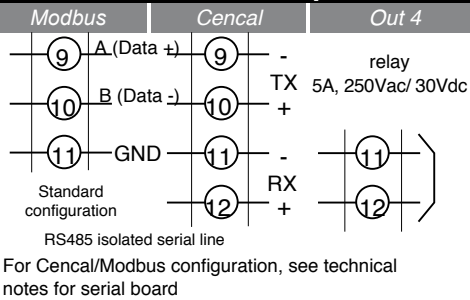

• Inputs

• TC input

Available thermocouples:
J, K, R, S, T, B, E, N,
L, U, G, D, C
- Respect polarities
- For extensions, use
compensated cable
appropriate for thermocouple

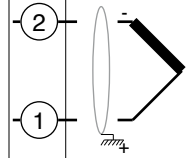

• Linear input with 3-wire transmitter

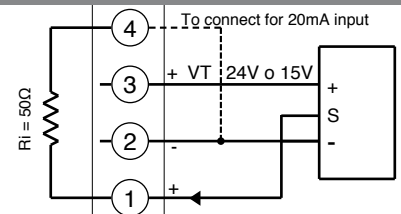

• Linear input (V)

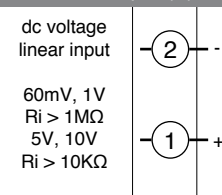

• Linear input (I)

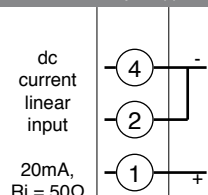

• Linear input with 2-wire transmitter

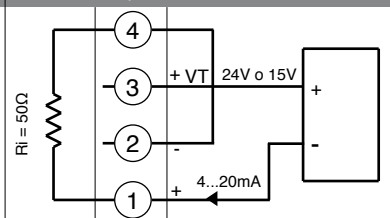

• Linear input 1V for potentiometer

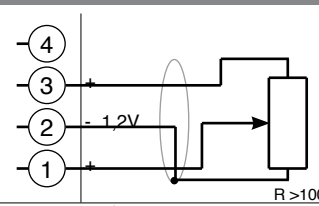

• Pt100 / PTC / NTC

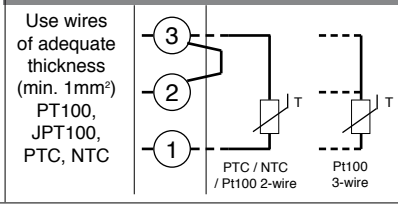

Connections for keylock function through digital input
(require selection +VT for the signal on contact 3)

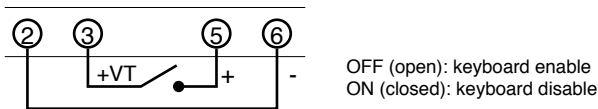

• Device structure

SERIAL INTERFACE/OUT4

CPU

DISPLAY

POWER

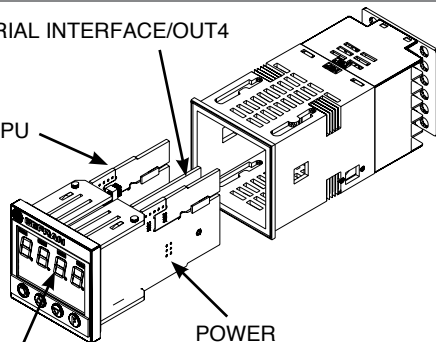

• Identification of boards

Power supply board
Solder side

Selection of
Transmitter
supply voltage

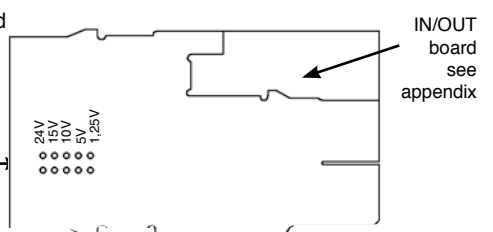

IN/OUT
board see
appendix

CPU board
Component side

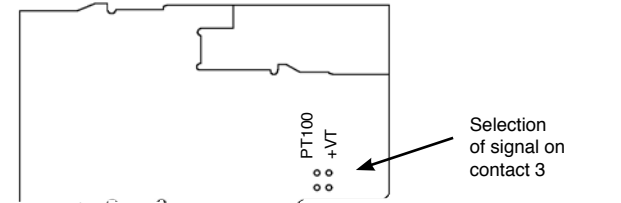

N.B. : you can keep the OUT1 relay energized at power-up by inserting jumper S2 and removing resistance R20.

5 · PROGRAMMING and CONFIGURATION

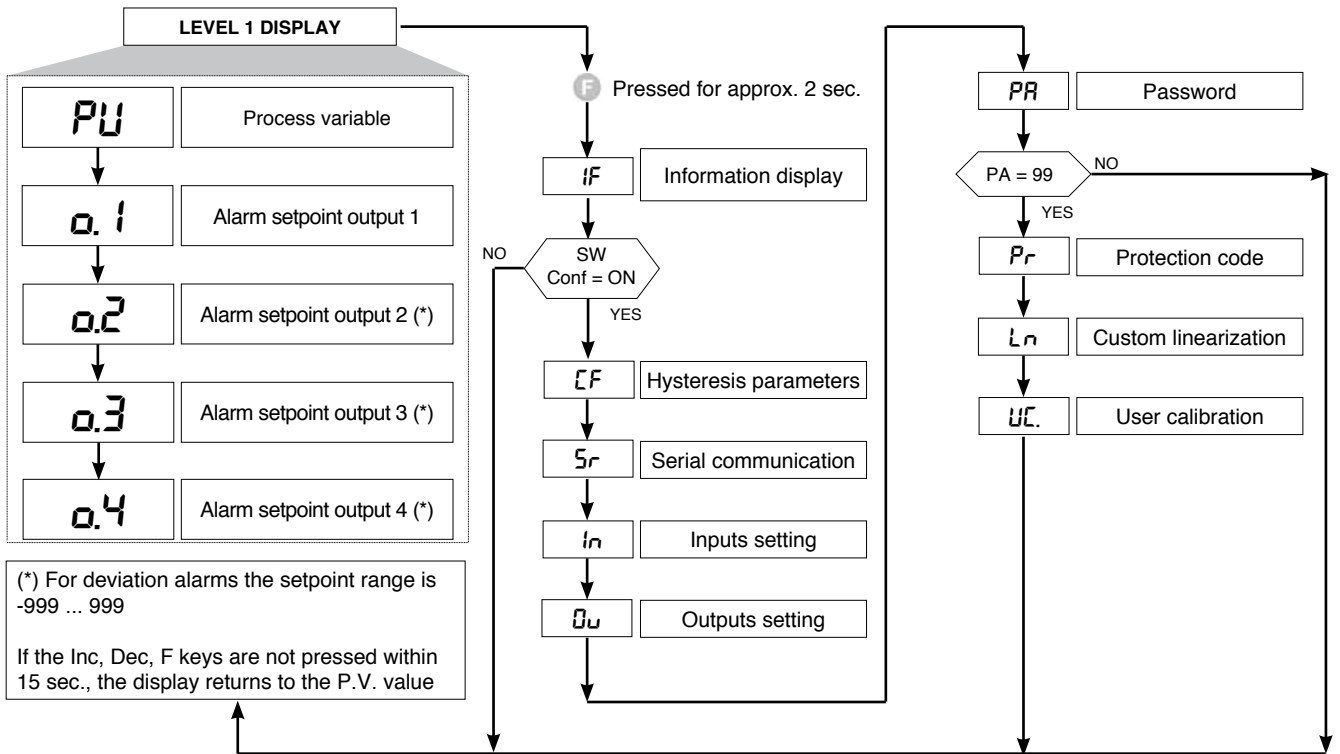

Keep the F key pressed to browse the menus.
Release the F key to enter the displayed menu.
Press the F key to access the parameters.
Keep the F key pressed to exit any menu at any time

· Information display

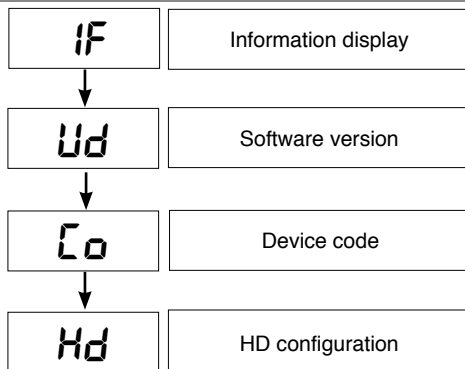

· Hysteresis parameters

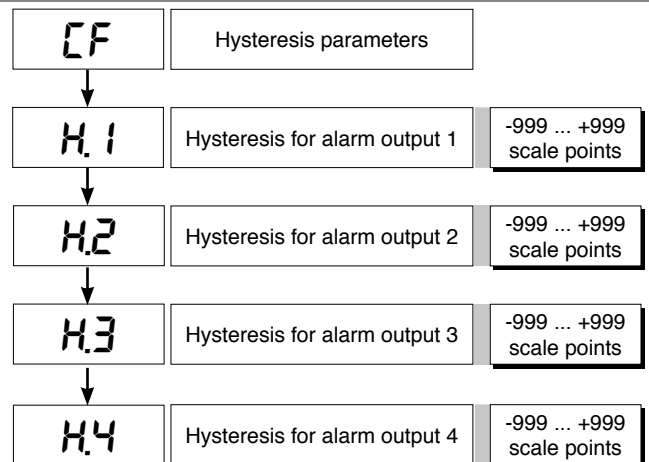

· IF Display



OUTPUT 2 / OUTPUT 1
0 = Absent / Absent
1 = Relay / Relay
2 = Logic / Relay
3 = Triac / Relay

INPUT / OUTPUT 3
0 = Absent
1 = Relay
2 = Logic
4 = Analogi
6 = In Digital

DIGITAL COMMUNICATION / OUT4
0 = Absent
1 = RS 485
2 = Relay

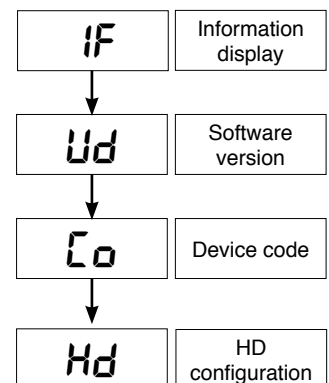

Example: 1 1 1 = R + R + RS 485

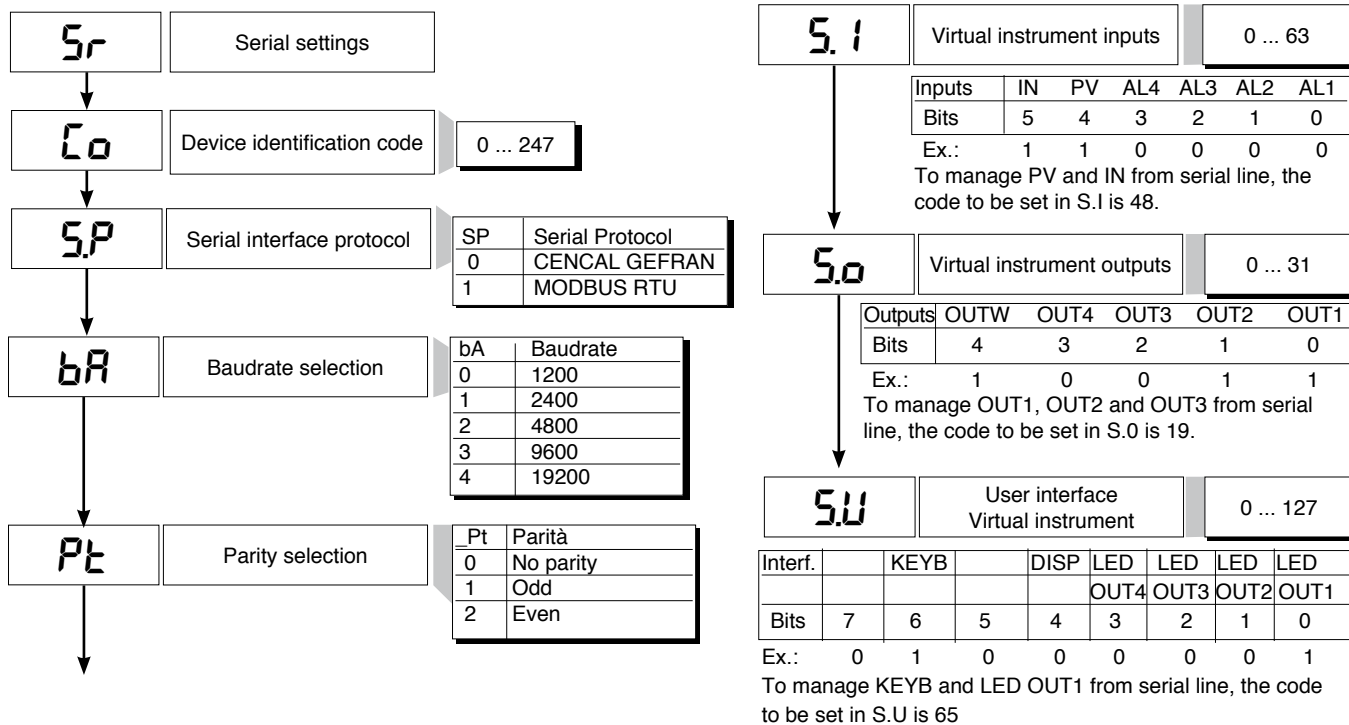

• TC / LIN input parameters

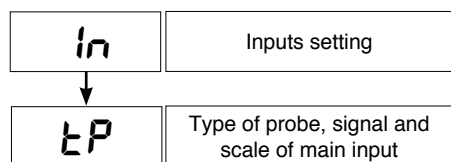

tP	PROBE TYPE	without dec. point	with dec. point
Probe: TC			
0	TC J °C	0/1000	0.0/999.9
1	TC J °F	32/1832	32.0/999.9
2	TC K °C	0/1300	0.0/999.9
3	TC K °F	32/2372	32.0/999.9
4	TC R °C	0/1750	0.0/999.9
5	TC R °F	32/3182	32.0/999.9
6	TC S °C	0/1750	0.0/999.9
7	TC S °F	32/3182	32.0/999.9
8	TC T °C	-200/400	-199.9/400.0
9	TC T °F	-328/752	-199.9/752.0
10	TC B °C	44/1800	44.0/999.9
11	TC B °F	111/3272	111.0/999.9
12	TC E °C	-100/750	-100.0/750.0
13	TC E °F	-148/1382	-148.0/999.9
14	TC N °C	0/1300	0.0/999.9
15	TC N °F	32/2372	32.0/999.9
16	TC LGOST °C	0/600	0.0/600.0
17	TC LGOST °F	32/1112	32.0/999.9
18	TC U °C	-200/400	-199.9/400.0
19	TC U °F	-328/752	-199.9/752.0
20	TC G °C	0/2300	0.0/999.9
21	TC G °F	32/4172	32.0/999.9
22	TC D °C	0/2300	0.0/999.9
23	TC D °F	32/4172	32.0/999.9
24	TC C °C	0/2300	0.0/999.9
25	TC C °F	32/4172	32.0/999.9
26	TC °C	Custom	Custom
27	TC °F	Custom	Custom
Probe: RTD			
28	PT100 °C	-200/850	-199.9/850.0
29	PT100 °F	-328/1562	-199.9/999.9
30	JPT100 °C	-200/600	-199.9/600.0
31	JPT100 °F	-328/1112	-199.9/999.9
Probe: PTC - NTC			
32	PTC °C	-55/120	-55.0/120.0
33	PTC °F	-67/248	-67.0/248.0
34	NTC °C	-10/70	-10.0/70.0
35	NTC °F	14/158	14.0/158.0

tP	PROBE TYPE	without decimal point	with decimal point
Probe: Voltage + Current			
36	0...60mV	-1999/9999	-199.9/999.9
37	0...60mV	linear custom	linear custom
38	12...60mV	-1999/9999	-199.9/999.9
39	12...60mV	linear custom	linear custom
40	0...20mA	-1999/9999	-199.9/999.9
41	0...20mA	linear custom	linear custom
42	4...20mA	-1999/9999	-199.9/999.9
43	4...20mA	linear custom	linear custom
44	0...10V	-1999/9999	-199.9/999.9
45	0...10V	linear custom	linear custom
46	2...10V	-1999/9999	-199.9/999.9
47	2...10V	linear custom	linear custom
48	0...5V	-1999/9999	-199.9/999.9
49	0...5V	linear custom	linear custom
50	1...5V	-1999/9999	-199.9/999.9
51	1...5V	linear custom	linear custom
52	0...1V	-1999/9999	-199.9/999.9
53	0...1V	linear custom	linear custom
54	200mV...1V	-1999/9999	-199.9/999.9
55	200mV...1V	linear custom	linear custom
Probe: Custom PT100 - PTC - NTC			
56	PT100 JPT	custom	custom
57	PTC	custom	custom
58	NTC	custom	custom

In case of custom linearization, test limits for setting LO and HI errors are given by the calibration values. If these limits are not exceeded, they are taken into consideration as limits L.S and H.S.

N.B.: for the version R77 and R98 are not available the probe codes 0...39, 48...51, 54...58

Max. non-linearity error for thermocouples (TC), resistors (PT100) and thermistors (PTC, NTC)

The error is calculated as deviation from theoretical value and is expressed as percentage of full scale (in °C)

- S, R** range 0...1750°C; error < 0.2% f.s. (t > 300°C) for other range; error < 0.5% f.s.
- T** error < 0.2% f.s. (t > -150°C)
- B** range 44...1800°C; error < 0.5% f.s. (t > 300°C) range 44,0...999,9; error < 1% f.s. (t > 300°C)
- U** range -99,9...99,9 e -99...99°C; error < 0.5% f.s. for other range; errore < 0.2% f.s. (t > -150°C)
- G** error < 0.2% f.s. (t > 300°C)
- D** error < 0.2% f.s. (t > 200°C)
- C** range 0...2300; error < 0.2% f.s. for other range; error < 0.5% f.s.
- NTC** errore < 0.5% f.s.
- Tc type **J, K, E, N, L** error < 0,2% f.s.
- JPT100 e PTC** error < 0,2% f.s.
- PT100** range -200...850°C accuracy at 25°C lower than 0,2% f.s.. In range 0...50°C:
 - accuracy lower than 0,2% f.s. in range -200...400°C
 - accuracy lower than 0,4% f.s. in range +400...850°C (where f.s. is referred to range -200...850°C)

• TC / LIN input parameters

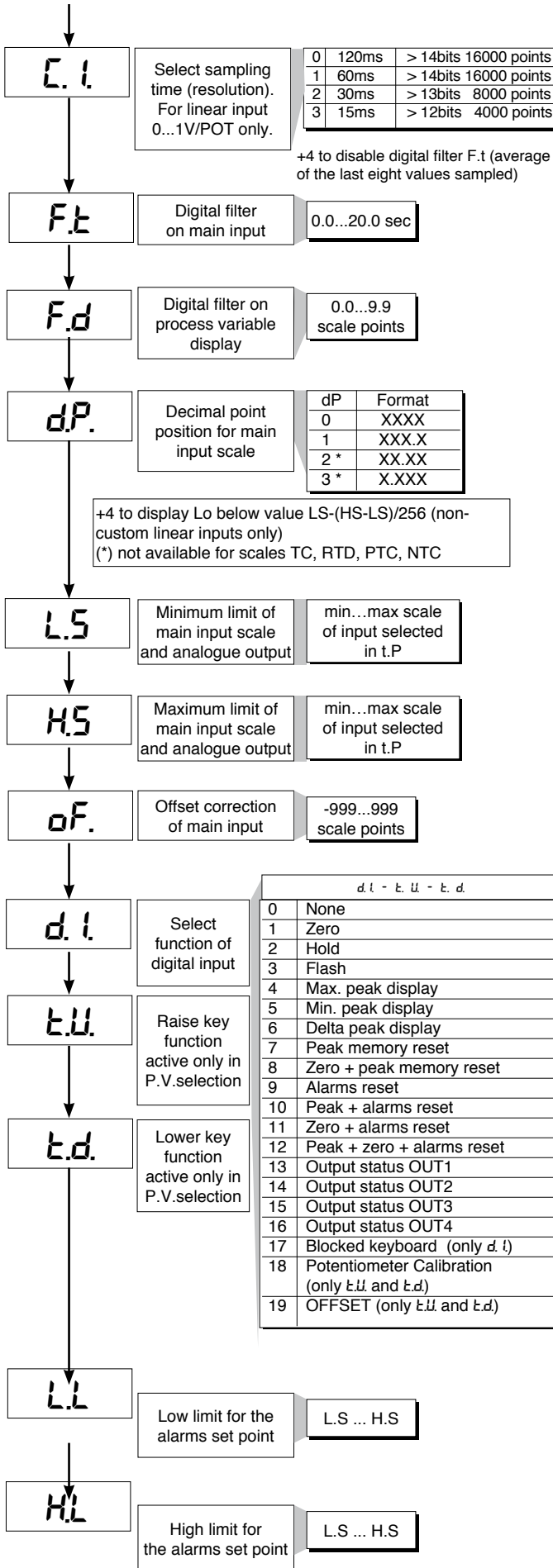

• Output parameters

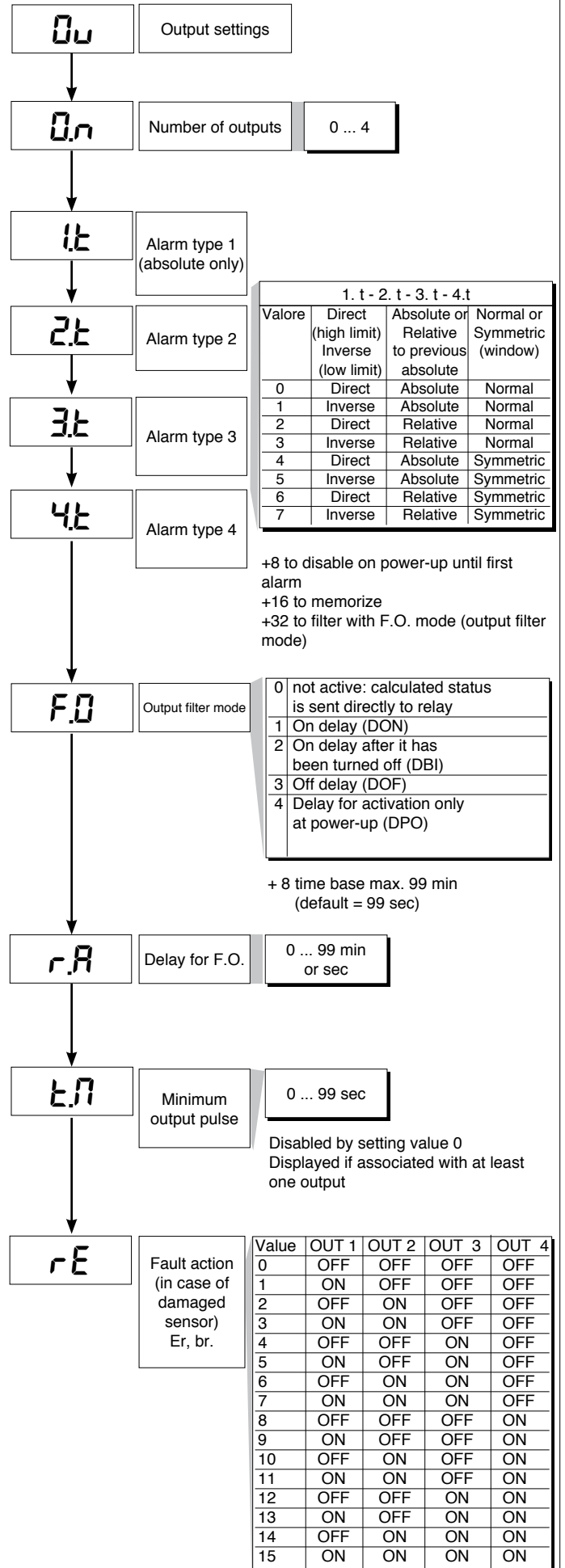

• Protection

Protection code	Value	Displayed parameters	Modifiable parameters
Pr	0	o.1, o.2, o.3, o.4	o.1, o.2, o.3, o.4
	1	o.1, o.2	o.1, o.2
	2	o.1	o.1
	3	o.1	none

- +4 to disable In and Ou pages
- +8 to disable CF and Sr pages
- +16 to enable maintenance of reset latch at power-off (for linear inputs only)
- +32 base configuration (the following parameters will not be displayed):

In: F.t, F.d, oF., L.L, H.L

Ou: On [forced to no. outputs present], rE)

F.t, F.d, oF., remain at set value

L.L, H.L are forced to L.S, H.S

- +64 Management of virtual instrument

- +128 Disabilitazione of all the menu except PA (Password)

• Custom linearization

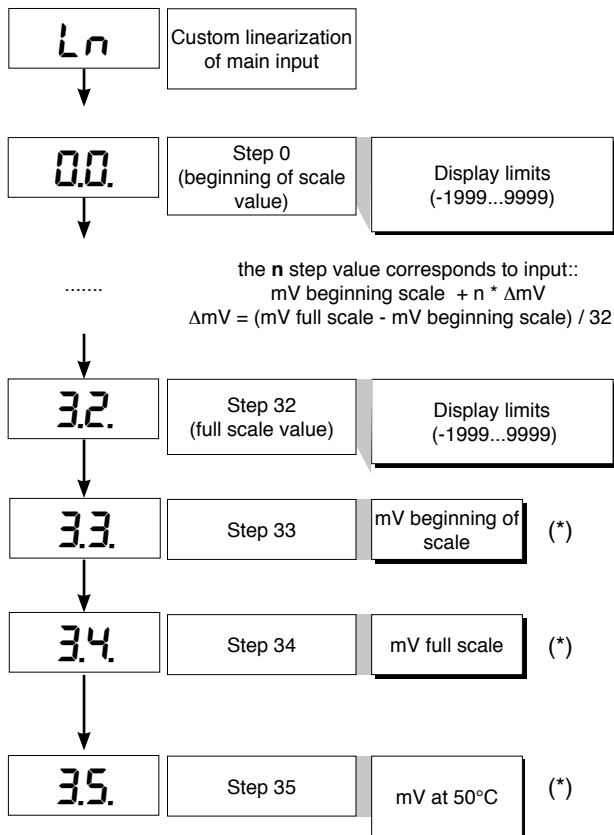

(*) only for CPU, TC_LIN e tP = TC CUSTOM

• User calibration

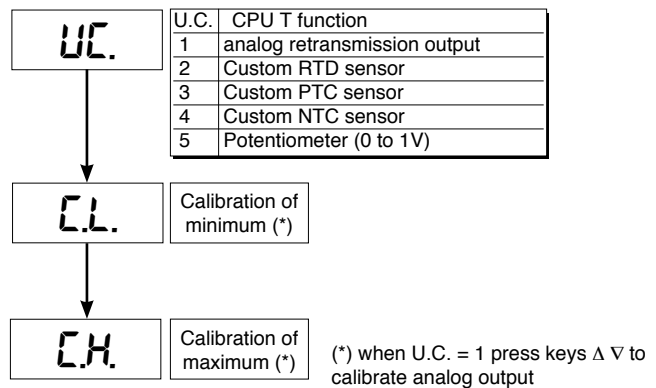

• HOLD function

The input value and alarms remain “frozen” for the interval in which the logic input is active.

With the input active, a reset of the alarm memory provokes de-energizing of all the energized relays and resetting of the memory of all the alarms.

• FLASH function

Input value is sampled; state of alarms is not transferred to outputs; outputs are “frozen”.

When the logic input is active the input value is “frozen” and the outputs are updated according to the calculated alarms state, including the ones latched.

6 · ALARMS

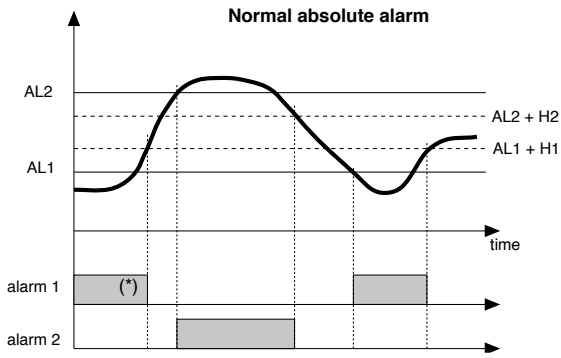

For AL1 inverse absolute alarm (min.) with positive H1, 1 t = 1
 (*) = OFF if disabling on power-on exists
 For AL2 direct absolute alarm (max) with negative H2, 2 t = 0

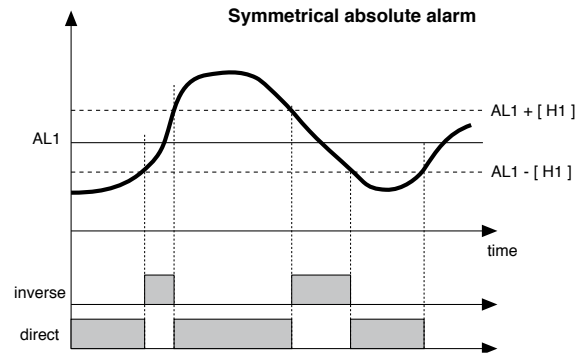

For AL1 inverse absolute, symmetrical alarm with hysteresis H1, 1 t = 5
 For AL1 direct absolute, symmetrical alarm with hysteresis H1, 1 t = 4

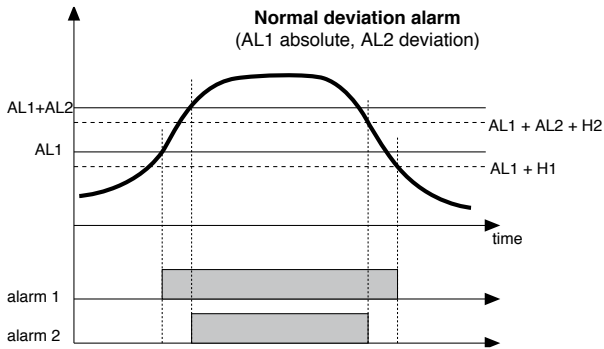

For AL1 direct absolute alarm (max) with negative H1, 1 t = 0
 For AL2 direct relative alarm (max) with negative H2, 2 t = 2

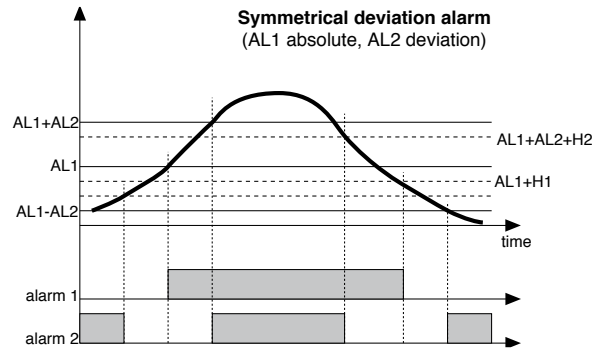

For AL1 direct absolute alarm (max) with negative H1, 1 t = 0
 For AL2 symmetrical deviation alarm H2, 2 t = 6

•Filter - outputs with reference to parameters F.0 and r.A

The diagrams refer to a normal absolute alarm with hysteresis H = 0

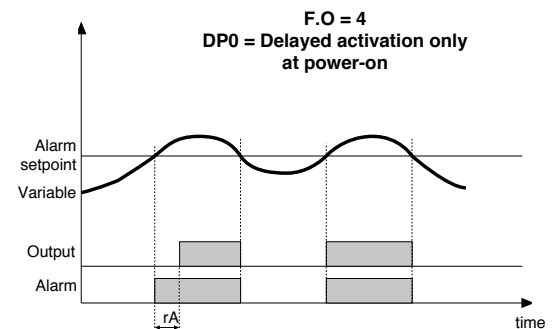
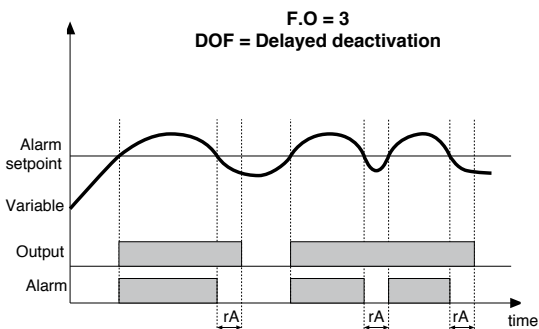
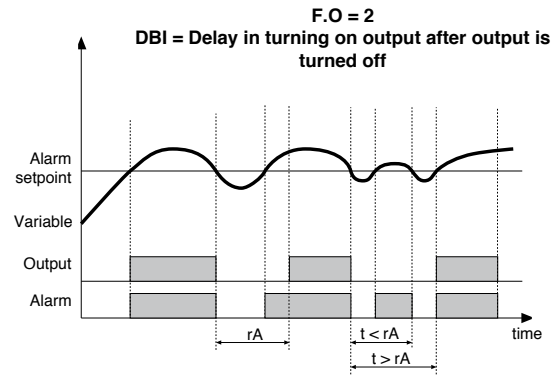
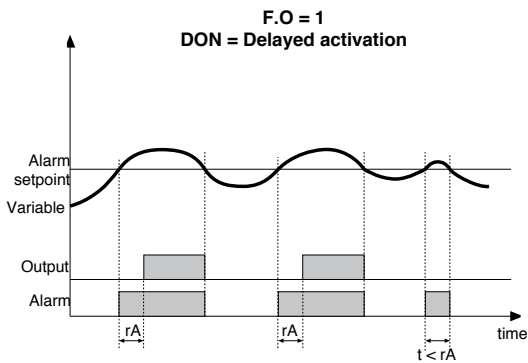

• Interface for GEFRAN instrument configuration

KIT PC USB / RS485 o TTL



Kit for PC via the USB port (Windows environment) for GEFRAN instruments configuration:
Lets you read or write all of the parameters

- A single software for all models
- Easy and rapid configuration
- Saving and management of parameter recipes
- On-line trend and saving of historical data

Component Kit:

- Connection cable PC USB ... port TTL
- Connection cable PC USB ... RS485 port
- Serial line converter
- CD SW GF Express installation

• ORDERING CODE

GF_eXK-2-0-0 cod F049095

ORDER CODE

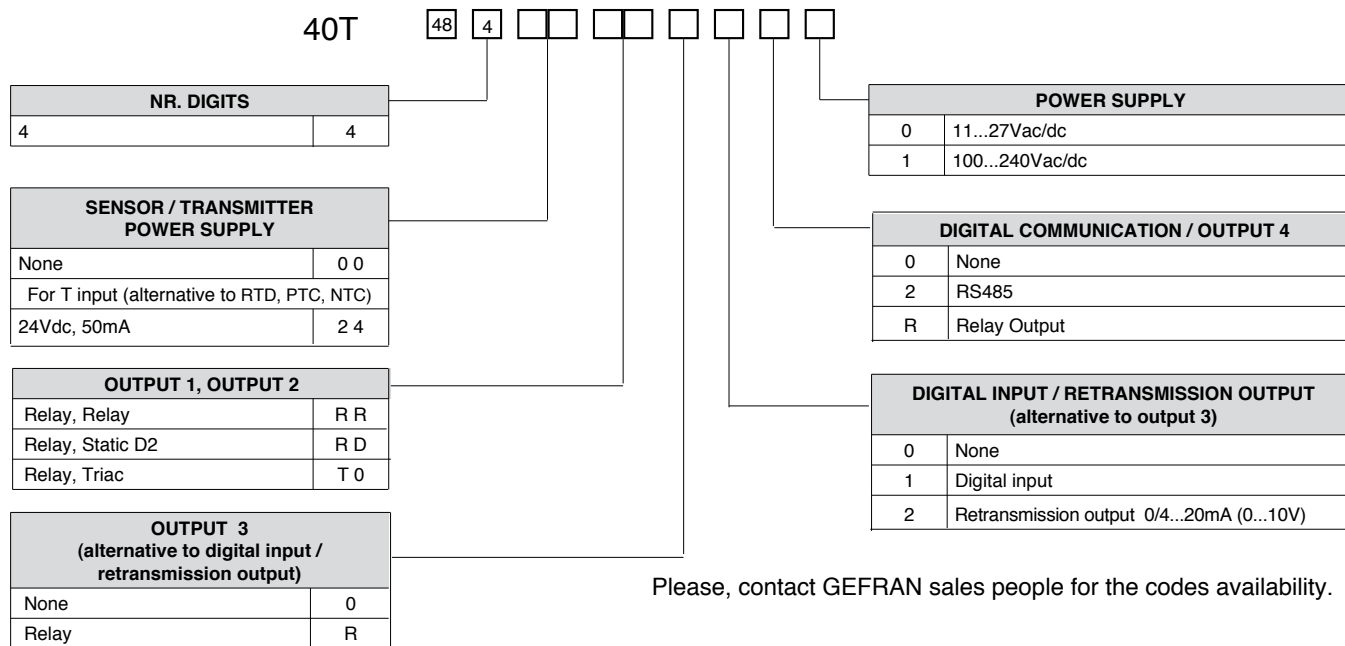

* R77 and R98 for potentiometer input (R input >10Mohm)
Digital input always available in versions R77

• WARNINGS



WARNING: this symbol indicates danger.

It is seen near the power supply circuit and near high-voltage relay contacts.

Read the following warnings before installing, connecting or using the device:

- follow instructions precisely when connecting the device.
- always use cables that are suitable for the voltage and current levels indicated in the technical specifications.
- the device has NO on/off switch: it switches on immediately when power is turned on. For safety reasons, devices permanently connected to the power supply require a two-phase disconnecting switch with proper marking. Such switch must be located near the device and must be easily reachable by the user. A single switch can control several units.
- if the device is connected to electrically NON-isolated equipment (e.g. thermocouples), a grounding wire must be applied to assure that this connection is not made directly through the machine structure.
- if the device is used in applications where there is risk of injury to persons and/or damage to machines or materials, it MUST be used with auxiliary alarm units. You should be able to check the correct operation of such units during normal operation of the device.
- before using the device, the user must check that all device parameters are correctly set in order to avoid injury to persons and/or damage to property.
- the device must NOT be used in inflammable or explosive environments. It may be connected to units operating in such environments only by means of suitable interfaces in conformity to local safety regulations.
- the device contains components that are sensitive to static electrical discharges. Therefore, take appropriate precautions when handling electronic circuit boards in order to prevent permanent damage to these components

Installation: installation category II, pollution level 2, double isolation

The equipment is intended for permanent indoor installations within their own enclosure or panel mounted enclosing the rear housing and exposed terminals on the back.

- power supply lines must be separated from device input and output lines; always check that the supply voltage matches the voltage indicated on the device label.
- install the instrumentation separately from the relays and power switching devices
- do not install high-power remote switches, contactors, relays, thyristor power units (particularly if "phase angle" type), motors, etc... in the same cabinet.
- avoid dust, humidity, corrosive gases and heat sources.
- do not close the ventilation holes; working temperature must be in the range of 0...50°C.

If the device has faston terminals, they must be protected and isolated; if the device has screw terminals, wires should be attached at least in pairs.

- **Power:** supplied from a disconnecting switch with fuse for the device section; path of wires from switch to devices should be as straight as possible; the same supply should not be used to power relays, contactors, solenoid valves, etc.; if the voltage waveform is strongly distorted by thyristor switching units or by electric motors, it is recommended that an isolation transformer be used only for the devices, connecting the screen to ground; it is important for the electrical system to have a good ground connection; voltage between neutral and ground must not exceed 1V and resistance must be less than 60hm; if the supply voltage is highly variable, use a voltage stabilizer for the device; use line filters in the vicinity of high frequency generators or arc welders; power supply lines must be separated from device input and output lines; always check that the supply voltage matches the voltage indicated on the device label
- **input and output connections:** external connected circuits must have double insulation; to connect analog inputs (TC, RTD) you have to: physically separate input wiring from power supply wiring, from output wiring, and from power connections; use twisted and screened cables, with screen connected to ground at only one point; to connect adjustment and alarm outputs (contactors, solenoid valves, motors, fans, etc.), install RC groups (resistor and capacitor in series) in parallel with inductive loads that work in AC (Note: all capacitors must conform to VDE standards (class x2) and support at least 220 VAC. Resistors must be at least 2W); fit a 1N4007 diode in parallel with the coil of inductive loads that operate in DC

GEFRAN spa will not be held liable for any injury to persons and/or damage to property deriving from tampering, from any incorrect or erroneous use, or from any use not conforming to the device specifications.

• SCHEDE INGRESSI / USCITE
• INPUT/OUTPUT BOARDS
• E/A-KARTEN

• CARTES D'ENTREES/SORTIES
• FICHAS ENTRADAS/SALIDAS
• PLACAS DE ENTRADAS/SAÍDAS

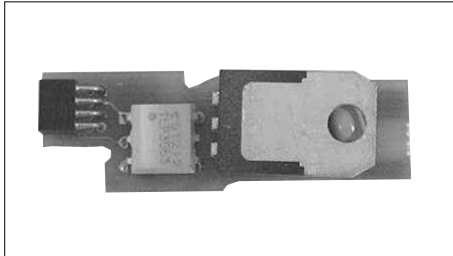

USCITA TRIAC (OUT2)
TRIAC OUTPUT (OUT2)
TRIAC-AUSGANG (OUT2)
SORTIE TRIAC (OUT2)
SALIDA TRIAC (OUT2)
SAÍDA TRIAC (OUT2)

PROFILO

Questa scheda supporta la funzione di uscita prevista come OUT2 nello strumento 40T48. Adatta a pilotare carichi in ca sino ad un massimo di 240Vac, 1A. La schedina è automaticamente riconosciuta dallo strumento che abilita visibilità ed impostazione dei parametri relativi.

PROFILE

This board supports the output function provided as OUT2 on the 40T48 instrument. Suitable for piloting AC loads up to a maximum of 240V AC, 1A. The board is automatically recognized by the instrument, which enables display and setting of the parameters involved.

BESCHREIBUNG

Diese Karte unterstützt die als OUT2 beim Instrument 40T48 vorgesehene Ausgangsfunktion. Sie eignet sich zur Steuerung von Wechselstromlasten bis maximal 240Vac, 1A. Das Gerät erkennt die Karte automatisch und aktiviert die Funktionen für die Anzeige und die Einstellung der entsprechenden Parameter.

GENERALITES

Cette carte supporte la fonction sortie prévue comme OUT2 dans l'outil 40T48. Elle est apte à piloter les charges en ca jusqu'à un maximum de 240Vca, 1A. La carte est automatiquement reconnue par l'outil qui habilite la visibilité et la programmation des paramètres appropriés.

PERFIL

Esta ficha soporta la función de salida prevista como OUT2 en el instrumento 40T48. Idónea para pilotear las cargas en ca hasta un máximo de 240 Vca, 1 A. La ficha es reconocida de modo automático por el instrumento, que habilita visibilidad y programación de los respectivos parámetros.

PERFIL

Esta placa suporta a função de saída prevista como OUT2 no instrumento 40T48. É indicada para pilotar cargas de ca até um máximo de 240Vca, 1A. A placa é reconhecida automaticamente pelo instrumento, que habilita a visibilidade e configuração dos respectivos parâmetros.

DATI TECNICI

24...240Vac $\pm 10\%$, 50/60Hz, 1A max
Snubberless, ammette carico induttivo e resistivo
 $I^2t=128A^2sec$
Corrente di perdita 1.5mA max a 200Vac
Protezione tramite fusibile (EFT-4) 4A, 220Vac NON sostituibile.

CARACTERISTIQUES TECHNIQUES

24...240Vca $\pm 10\%$, 50/60Hz, 1A maxi
'Snubberless', admet la charge inductive et résistive
 $I^2t=128A^2sec$
Courant de perte 1,5mA maxi à 200Vca
Protection par fusible (EFT-4) 4A, 220Vca NON remplaçable.

TECHNICAL DATA

24...240Vac $\pm 10\%$, 50/60Hz, 1A max
Snubberless, admits inductive and resistive load
 $I^2t=128A^2sec$
Leakage current 1.5mA max at 200Vac
Fuse protection (EFT-4) 4A, 220Vac NOT replaceable.

DATOS TÉCNICOS

24...240Vca $\pm 10\%$, 50/60Hz, 1A máx.
Snubberless, admite carga inductiva y resistiva $I^2t=128A^2sec$
Corriente de pérdida 1,5mA máx. a 200Vca
Protección mediante fusible (EFT-4) 4A, 220Vca NO sustituible.

TECHNISCHE DATEN

24...240Vac $\pm 10\%$, 50/60Hz, 1A max
Ungedämpft, für induktive und ohmsche Lasten $I^2t=128A^2sec$
Leckstrom 1,5mA max bei 200Vac
Schutz durch Sicherung (EFT-4) 4A, 220Vac NICHT austauschbar.

DADOS TÉCNICOS

24...240Vca $\pm 10\%$, 50/60Hz, 1A máx
Snubberless, admite carga indutiva e resistiva $I^2t=128A^2sec$
Corrente de fuga 1,5mA máx a 200Vca
Proteção mediante fusível (EFT-4) 4A, 220Vca NÃO substituível.



USCITA RELÉ (OUT2)
RELAY OUTPUT (OUT2)
RELAISAUSGANG (OUT2)
SORTIE RELAIS (OUT2)
SALIDA RELÉ (OUT2)
SAÍDA DE RELÉ (OUT2)

PROFILO

Questa scheda supporta la funzione di uscita prevista come OUT2 nello strumento 40T48. Adatta a pilotare carichi resistivi sino ad un massimo di 5A a 250Vac / 30Vdc. La schedina è automaticamente riconosciuta dallo strumento che abilita visibilità ed impostazione dei parametri relativi.

PROFILE

This board supports the output function provided as OUT2 on the 40T48 instrument. Suitable for piloting resistive loads up to a maximum of 5A at 250V AC/30Vdc. The board is automatically recognized by the instrument, which enables display and setting of the parameters involved.

BESCHREIBUNG

Diese Karte unterstützt die als OUT2 beim Instrument 40T48 vorgesehene Ausgangsfunktion. Sie eignet sich zum Steuern von ohmschen Lasten bis maximal 5A bei 250Vac/30Vdc. Das Gerät erkennt die Karte automatisch und aktiviert die Funktionen für die Anzeige und die Einstellung der entsprechenden Parameter.

GENERALITES

Cette carte supporte la fonction sortie prévue comme OUT2 dans l'outil 40T48. Elle est apte à piloter des charges résistives jusqu'à un maximum de 5A à 250Vca/30Vcc. La carte est automatiquement reconnue par l'outil qui habilite la visibilité et la programmation des paramètres appropriés.

PERFIL

Esta ficha soporta la función de salida prevista como OUT2 en el instrumento 40T48. Idónea para pilotar las cargas resistivas hasta un máximo de 5 A a 250 Vca/30 Vcc. La ficha es reconocida de modo automático por el instrumento, que habilita visibilidad y programación de los respectivos parámetros.

PERFIL

Esta placa suporta a função de saída prevista como OUT2 no instrumento 40T48. É indicada para pilotar cargas resistivas até um máximo de 5A a 250Vca/30Vcc. A placa é reconhecida automaticamente pelo instrumento, que habilita a visibilidade e configuração dos respectivos parâmetros.

DATI TECNICI

Relè a singolo contatto NO
 Corrente max 5A a 250Vac / 30Vdc $\cos\varphi = 1$
 Protezione MOV 275V 0.25W in parallelo al contatto
 È possibile ottenere il relè eccitato all'accensione tramite l'esecuzione del ponticello S1 e la rimozione della resistenza R4.

CARACTERISTIQUES TECHNIQUES

Relais à contact simple NO
 Courant maxi 5A à 250Vca / 30Vcc $\cos\varphi = 1$
 Protection MOV 275V 0,25W en parallèle au contact
 Il est possible d'obtenir le relais excité lors de la mise sous tension en exécutant le cavalier S1 et en retirant la résistance R4.

TECHNICAL DATA

Single-contact relay NO
 Max. current 5A at 250Vac / 30Vdc $\cos\varphi = 1$
 Protection MOV 275V 0.25W in parallel to contact
 The relay can be energized at power-up by installing jumper S1 and removing resistance R4.

DATOS TÉCNICOS

Relé de contacto único NA
 Corriente máx. 5A a 250Vca / 30Vcc $\cos\varphi = 1$
 Protección MOV 275 V 0,25 W en paralelo con contacto
 Es posible obtener la excitación del relé con el encendido mediante aplicación del puente S1 y remoción de la resistencia R4.

TECHNISCHE DATEN

Relais mit einem Schließer
 Max. Strom 5A bei 250Vac / 30Vdc $\cos\varphi = 1$
 MOV-Schutz 275V 0,25W parallel zum Kontakt
 Die Erregung des Relais bei der Einschaltung ist möglich, wenn man die Brücke S1 herstellt und den Widerstand R4 entfernt.

DADOS TÉCNICOS

Relé com contato único NA
 Corrente máx 5A a 250Vca / 30Vcc $\cos\varphi = 1$
 Proteção MOV 275V 0,25W em paralelo no contato
 É possível ter o relé excitado no momento de ligação, construindo a ponte S1 e removendo a resistência R4.

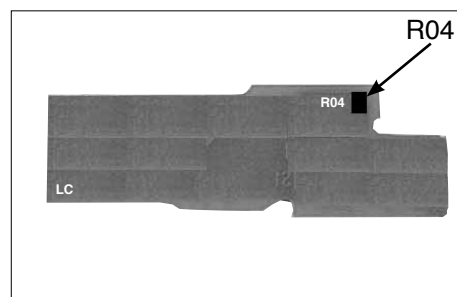
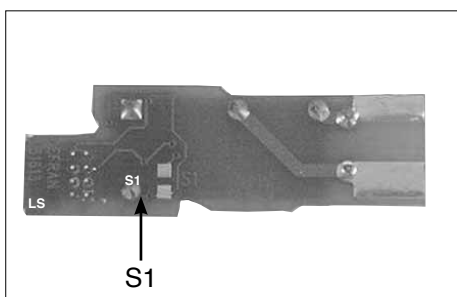

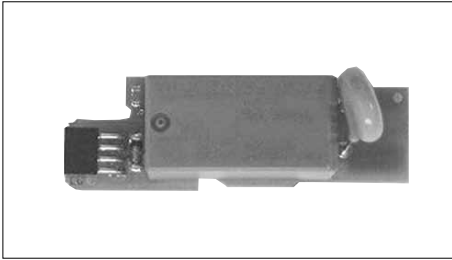

USCITA RELÉ (OUT3)
RELAY OUTPUT (OUT3)
RELAISAUSGANG (OUT3)
SORTIE RELAIS (OUT3)
SALIDA RELÉ (OUT3)
SAÍDA DE RELÉ (OUT3)

PROFILO

Questa scheda supporta la funzione di uscita prevista come OUT3 nello strumento 40T48. Adatta a pilotare carichi resistivi sino ad un massimo di 5A a 250Vac / 30Vdc. La schedina è automaticamente riconosciuta dallo strumento che abilita visibilità ed impostazione dei parametri relativi.

PROFILE

This board supports the output function provided as OUT3 on the 40T48 instrument. Suitable for piloting resistive loads up to a maximum of 5A at 250V AC/30Vdc. The board is automatically recognized by the instrument, which enables display and setting of the parameters involved.

BESCHREIBUNG

Diese Karte unterstützt die als OUT3 beim Instrument 40T48 vorgesehene Ausgangsfunktion. Sie eignet sich zum Steuern von ohmschen Lasten bis maximal 5A bei 250Vac/30Vdc. Das Gerät erkennt die Karte automatisch und aktiviert die Funktionen für die Anzeige und die Einstellung der entsprechenden Parameter.

GENERALITES

Cette carte supporte la fonction sortie prévue comme OUT3 dans l'outil 40T48. Elle est apte à piloter des charges résistives jusqu'à un maximum de 5A à 250Vca/30Vcc. La carte est automatiquement reconnue par l'outil qui habilite la visibilité et la programmation des paramètres appropriés.

PERFIL

Esta ficha soporta la función de salida prevista como OUT3 en el instrumento 40T48. Idónea para pilotear las cargas resistivas hasta un máximo de 5 A a 250 Vca/30 Vcc. La ficha es reconocida de modo automático por el instrumento, que habilita visibilidad y programación de los respectivos parámetros.

PERFIL

Esta placa suporta a função de saída prevista como OUT3 no instrumento 40T48. É indicada para pilotar cargas resistivas até um máximo de 5A a 250Vca/30Vcc. A placa é reconhecida automaticamente pelo instrumento, que habilita a visibilidade e configuração dos respectivos parâmetros.

DATI TECNICI

Relè a singolo contatto NO
 Corrente max 5A a 250Vac / 30Vdc $\cos\phi = 1$
 Protezione MOV 275V 0.25W in parallelo al contatto
 È possibile ottenere il relè eccitato all'accensione tramite l'esecuzione del ponticello S1 e la rimozione della resistenza R4.

CARACTERISTIQUES TECHNIQUES

Relais à contact simple NO
 Courant maxi 5A à 250Vca / 30Vcc $\cos\phi = 1$
 Protection MOV 275V 0,25W en parallèle au contact
 Il est possible d'obtenir le relais excité lors de la mise sous tension en exécutant le cavalier S1 et en retirant la résistance R4.

TECHNICAL DATA

Single-contact relay NO
 Max. current 5A at 250Vac / 30Vdc $\cos\phi = 1$
 Protection MOV 275V 0.25W in parallel to contact
 The relay can be energized at power-up by installing jumper S1 and removing resistance R4.

DATOS TÉCNICOS

Relé de contacto único NA
 Corriente máx. 5A a 250Vca / 30Vcc $\cos\phi = 1$
 Protección MOV 275 V 0,25 W en paralelo con contacto
 Es posible obtener la excitación del relé con el encendido mediante aplicación del puente S1 y remoción de la resistencia R4.

TECHNISCHE DATEN

Relais mit einem Schließer
 Max. Strom 5A bei 250Vac / 30Vdc $\cos\phi = 1$
 MOV-Schutz 275V 0,25W parallel zum Kontakt
 Die Erregung des Relais bei der Einschaltung ist möglich, wenn man die Brücke S1 herstellt und den Widerstand R4 entfernt.

DADOS TÉCNICOS

Relé com contato único NA
 Corrente máx 5A a 250Vca / 30Vcc $\cos\phi = 1$
 Proteção MOV 275V 0,25W em paralelo no contato
 É possível ter o relé excitado no momento de ligação, construindo a ponte S1 e removendo a resistência R4.

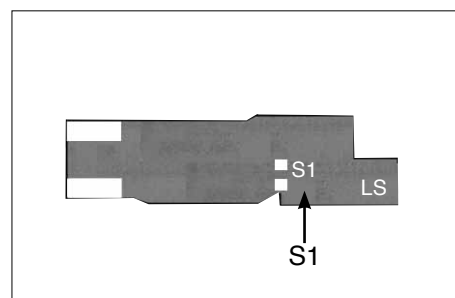
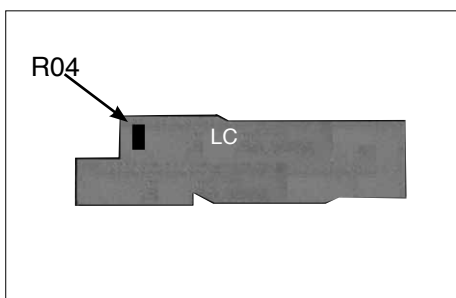

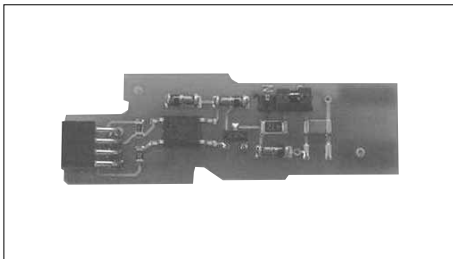

INGRESSO DIGITALE (OUT3)
DIGITAL INPUT (OUT3)
DIGITALEINGANG (OUT3)
ENTREE LOGIQUE(OUT3)
ENTRADA DIGITAL (OUT3)
ENTRADA DIGITAL (OUT3)

PROFILO

Questa scheda supporta la funzione di ingresso logico come alternativa ad OUT3 nello strumento 40T48. Comando da contatto pulito o da tensione 24V. La schedina è automaticamente riconosciuta dallo strumento che abilita visibilità ed impostazione dei parametri relativi.

PROFILE

This board supports the logic input function as alternative to OUT3 on the 40T48 instrument. Command from clean contact of 24V. The board is automatically recognized by the instrument, which enables display and setting of the parameters involved.

BESCHREIBUNG

Diese Karte unterstützt die Logikeingang-Funktion als Alternative zum OUT3 beim Gerät 40T48. Steuerung von potentialfreiem Kontakt oder mit Spannung 24V. Das Gerät erkennt die Karte automatisch und aktiviert die Funktionen für die Anzeige und die Einstellung der entsprechenden Parameter.

GENERALITES

Cette carte supporte la fonction entrée logique en tant qu'alternative à OUT3 dans l'outil 40T48. Commande par contact propre ou tension 24V. La carte est automatiquement reconnue par l'outil qui habilite la visibilité et la programmation des paramètres appropriés.

PERFIL

Esta ficha soporta la función de entrada lógica como alternativa a OUT3 en el instrumento 40T48. Mando de contacto limpio o de tensión 24 V. La ficha es reconocida de modo automático por el instrumento, que habilita visibilidad y programación de los respectivos parámetros.

PERFIL

Esta placa suporta a função de entrada lógica como alternativa de OUT3 no instrumento 40T48. Comando proveniente de contato limpo ou de tensão de 24V. A placa é reconhecida automaticamente pelo instrumento, que habilita a visibilidade e configuração dos respectivos parâmetros.

DATI TECNICI

Ingresso da contatto libero da tensione o 24Vdc / 5mA
 L'ingresso 24V è isolato a 1500V. La schedina in versione standard è configurata per ingresso 24V / 5mA. È possibile configurare l'ingresso per contatto libero da tensione tramite jumper.

Tipo di ingresso	Jumper S1 (doppio)
da contatto	N (entrambi)
24V	P (entrambi)

TECHNICAL DATA

Input from voltage-free contact or 24V DC/5mA.
 The 24V input is isolated 1500V. The standard card is configured for the 24V / 5 mA input. The input can be configured voltage-free contact by means of jumper.

Input type	Jumper S1 (double)
from contact	N (both)
24V	P (both)

TECHNISCHE DATEN

Eingang von potentialfreiem Kontakt oder 24Vdc/5mA.
 Der 24V-Eingang ist isoliert bis 1500V. In der Standardausführung ist die Karte für ein Eingangssignal 24V / 5 mA konfiguriert. Mit einem Jumper kann man den Eingang für einen potentialfreien Kontakt konfigurieren.

Eingangstyp	Jumper S1 (doppeltes)
von Kontakt	N (beide)
24V	P (beide)

CARACTERISTIQUES TECHNIQUES

Entrée par contact exempt de tension ou 24Vcc / 5mA
 L'entrée 24V est isolée 1500V. La carte en version standard est configurée pour l'entrée 24V / 5 mA. Il est possible de configurer l'entrée pour contact exempt de tension par le biais d'un cavalier.

Type d'entrée	Cavalier S1 (double)
par contact	N (tous les deux)
24V	P (tous les deux)

DATOS TÉCNICOS

Entrada de contacto libre de tensión o 24 Vcc/5 mA. La entrada 24 V está aislada 1500V. La ficha en versión estándar está configurada para entrada 24 V/5 mA. Es posible configurar la entrada para contacto libre de tensión mediante jumper.

Tipo de entrada	Jumper S1 (doble)
desde contacto	N (ambos)
24V	P (ambos)

DADOS TÉCNICOS

Entrada de contato livre de tensão ou 24Vdc / 5mA
 A entrada de 24V está isolada 1500V. A placa na versão padrão está configurada para entrada de 24V / 5 mA. É possível configurar a entrada para contato livre de tensão mediante ponte (jumper).

Tipo de entrada	Jumper S1 (dobro)
de contato	N (ambos)
24V	P (ambos)

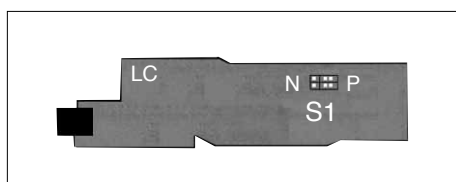

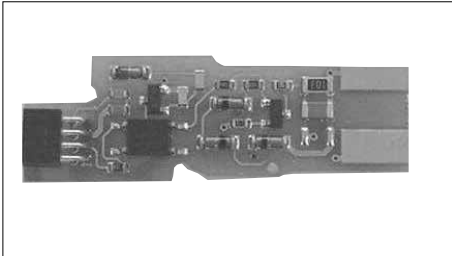

USCITA LOGICA (OUT3)
LOGIC OUTPUT (OUT3)
LOGIKAUSGANG (OUT3)
SORTIE LOGIQUE (OUT3)
SALIDA LÓGICA (OUT3)
SAÍDA LÓGICA (OUT3)

PROFILO

Questa scheda supporta la funzione di uscita prevista come OUT3 nello strumento 40T48.
Adatta a pilotare ingressi logici, applicazione tipica per interfaccia verso interruttori statici (GTS).
La schedina è automaticamente riconosciuta dallo strumento che abilita visibilità ed impostazione dei parametri relativi.

PROFILE

This board supports the output function provided as OUT3 on the 40T48 instrument.
Suitable for piloting logic inputs, typical application for interface to solid state switches (GTS).
The board is automatically recognized by the instrument, which enables display and setting of the parameters involved.

BESCHREIBUNG

Diese Karte unterstützt die als OUT3 beim Instrument 40T48 vorgesehene Ausgangsfunktion.
Geeignet für die Steuerung von Logikeingängen, typische Anwendung für Schnittstelle zu Halbleiterrelais (GTS).
Das Gerät erkennt die Karte automatisch und aktiviert die Funktionen für die Anzeige und die Einstellung der entsprechenden Parameter.

GENERALITES

Cette carte supporte la fonction sortie prévue comme OUT3 dans l'outil 40T48.
Elle est apte à piloter des entrées logiques, application typique pour l'interface vers des interrupteurs statiques (GTS).
La carte est automatiquement reconnue par l'outil qui habilite la visibilité et la programmation des paramètres appropriés.

PERFIL

Esta ficha soporta la función de salida prevista como OUT3 en el instrumento 40T48.
Idónea para pilotar entradas lógicas, aplicación típica para interfaz hacia interruptores estáticos (GTS).
La ficha es reconocida de modo automático por el instrumento, que habilita visibilidad y programación de los respectivos parámetros.

PERFIL

Esta placa suporta a função de saída prevista como OUT3 no instrumento 40T48.
É indicada para pilotar entradas lógicas, aplicação típica para interface versus interruptores estáticos (GTS).
A placa é reconhecida automaticamente pelo instrumento, que habilita a visibilidade e configuração dos respectivos parâmetros.

DATI TECNICI

24V \pm 10% (10V min a 20mA)
Limitazione di corrente a 30mA
È possibile pilotare direttamente gruppi statici GTS singolarmente o in serie per carichi trifase.

CARACTERISTIQUES TECHNIQUES

24V \pm 10% (10V mini à 20mA) Limitation de courant à 30mA
Il est possible de piloter directement des groupes statiques GTS individuellement ou en série, pour des charges triphasées.

TECHNICAL DATA

24V \pm 10 % (10V min at 20 mA)
Current limitation at 30mA
GTS solid state relays can be piloted directly, either individually or in series by three-phase loads.

DATOS TÉCNICOS

24V \pm 10% (10V mín. a 20mA)
Limitación de corriente a 30 mA
Es posible pilotar directamente grupos estáticos GTS de modo singular o en serie para cargas trifásicas.

TECHNISCHE DATEN

24V \pm 10% (10V bei a 20mA)
Strombegrenzung auf 30mA
Die Halbleiterrelais GTS können direkt entweder einzeln oder in Reihe für dreiphasige Lasten gesteuert werden.

DADOS TÉCNICOS

24V \pm 10% (10V mín a 20mA)
Limitação de corrente a 30 mA
É possível pilotar grupos estáticos, GTS, diretamente, individualmente ou em série, para cargas trifásicas.

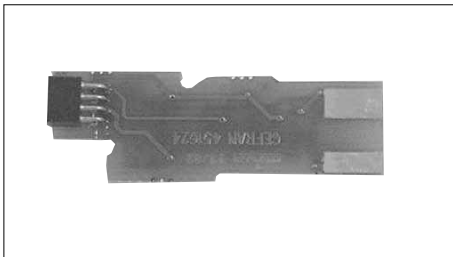

USCITA LOGICA (OUT2)
LOGIC OUTPUT (OUT2)
LOGIKAUSGANG (OUT2)
SORTIE LOGIQUE (OUT2)
SALIDA LÓGICA (OUT2)
SAÍDA LÓGICA (OUT2)

PROFILO

Questa scheda supporta la funzione di uscita prevista come OUT2 nello strumento 40T48.
Adatta a pilotare ingressi logici, applicazione tipica per interfaccia verso interruttori statici (GTS).
La scheda è automaticamente riconosciuta dallo strumento che abilita visibilità ed impostazione dei parametri relativi.

PROFILE

This board supports the output function provided as OUT2 on the 40T48 instrument.
Suitable for piloting logic inputs, typical application for interface to solid state switches (GTS).
The board is automatically recognized by the instrument, which enables display and setting of the parameters involved.

BESCHREIBUNG

Diese Karte unterstützt die als OUT2 beim Instrument 40T48 vorgesehene Ausgangsfunktion.
Geeignet für die Steuerung von Logikeingängen, typische Anwendung für Schnittstelle zu Halbleiterrelais (GTS).
Das Gerät erkennt die Karte automatisch und aktiviert die Funktionen für die Anzeige und die Einstellung der entsprechenden Parameter.

GENERALITES

Cette carte supporte la fonction sortie prévue comme OUT2 dans l'outil 40T48.
Elle est apte à piloter des entrées logiques, application typique pour l'interface vers des interrupteurs statiques (GTS).
La carte est automatiquement reconnue par l'outil qui habilite la visibilité et la programmation des paramètres appropriés.

PERFIL

Esta ficha soporta la función de salida prevista como OUT3 en el instrumento 40T48.
Idónea para pilotar entradas lógicas, aplicación típica para interfaz hacia interruptores estáticos (GTS).
La ficha es reconocida de modo automático por el instrumento, que habilita visibilidad y programación de los respectivos parámetros.

PERFIL

Esta placa suporta a função de saída prevista como OUT2 no instrumento 40T48.
É indicada para pilotar entradas lógicas, aplicação típica para interface versus interruptores estáticos (GTS).
A placa é reconhecida automaticamente pelo instrumento, que habilita a visibilidade e configuração dos respectivos parâmetros.

DATI TECNICI

24V \pm 10% (10V min a 20mA)
Limitazione di corrente a 30mA
È possibile pilotare direttamente gruppi statici GTS singolarmente o in serie per carichi trifase.

CARACTERISTIQUES TECHNIQUES

24V \pm 10% (10Vmini à 20mA)
Limitation de courant à 30mA Il est possible de piloter directement des groupes statiques GTS individuellement ou en série, pour des charges triphasées.

TECHNICAL DATA

24V \pm 10 % (10V min at 20 mA)
Current limitation at 30mA
GTS solid state relays can be piloted directly, either individually or in series by three-phase loads.

DATOS TÉCNICOS

24V \pm 10 % (10V mín a 20 mA)
Limitación de corriente a 30 mA
Es posible pilotar directamente grupos estáticos GTS de modo singular o en serie para cargas trifásicas.

TECHNISCHE DATEN

24V \pm 10% (10V bei a 20mA)
Strombegrenzung auf 30mA
Die Halbleiterrelais GTS können direkt entweder einzeln oder in Reihe für dreiphasige Lasten gesteuert werden.

DADOS TÉCNICOS

24V \pm 10 % (10V mín a 20 mA)
Limitação de corrente a 30 mA
É possível pilotar grupos estáticos, GTS, diretamente, individualmente ou em série, para cargas trifásicas.

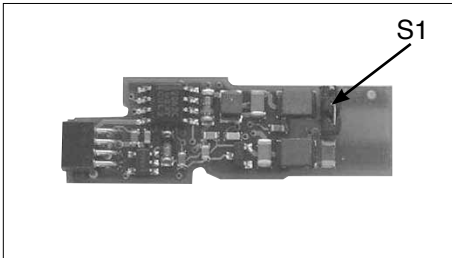

USCITA ANALOGICA (OUT3)
ANALOG OUTPUT (OUT3)
ANALOGAUSGANG (OUT3)
SORTIE ANALOGIQUE (OUT3)
SALIDA ANALÓGICA (OUT3)
SAÍDA ANALÓGICA (OUT3)

PROFILO

Questa scheda supporta la funzione di uscita prevista come OUT3 nello strumento 40T48. Normalmente utilizzata per la ritrasmissione del valore sonda. La schedina è automaticamente riconosciuta dallo strumento che abilita visibilità ed impostazione dei parametri relativi.

PROFILE

This board supports the output function provided as OUT3 on the 40T48 instrument. Normally used to retransmit the probe value. The board is automatically recognized by the instrument, which enables display and setting of the parameters involved.

BESCHREIBUNG

Diese Karte unterstützt die als OUT3 beim Instrument 40T48 vorgesehene Ausgangsfunktion. Normalerweise für die Weiterleitung des Fühlerwerts verwendet. Das Gerät erkennt die Karte automatisch und aktiviert die Funktionen für die Anzeige und die Einstellung der entsprechenden Parameter.

GENERALITES

Cette carte supporte la fonction sortie prévue comme OUT3 dans l'outil 40T48. Normalement utilisée pour la retransmission de la valeur de sonde. La carte est automatiquement reconnue par l'outil qui habilite la visibilité et la programmation des paramètres appropriés.

PERFIL

Esta ficha soporta la función de salida prevista como OUT3 en el instrumento 40T48. Normalmente utilizada para la retransmisión del valor sonda. La ficha es reconocida de modo automático por el instrumento, que habilita visibilidad y programación de los respectivos parámetros.

PERFIL

Esta placa suporta a função de saída prevista como OUT3 no instrumento 40T48. Normalmente, é utilizada para retransmissão do valor da sonda. A placa é reconhecida automaticamente pelo instrumento, que habilita a visibilidade e configuração dos respectivos parâmetros.

DATI TECNICI

Uscita standard 0/4...20mA su carico max 500Ω, accuratezza migliore dello 0.2% f.s. Risoluzione 12 bit. E' possibile configurare l'uscita in 0/2...10V tramite jumper che inserisce uno shunt di 500Ω in parallelo all' uscita, max corrente di cortocircuito 20mA. Accuratezza in assenza di calibrazione migliore dell'1% f.s. Nel caso si desideri un' accuratezza superiore effettuare la calibrazione utente (uscita analogica) come descritto nel manuale d' uso.

CARACTERISTIQUES TECHNIQUES

Sortie standard 0/4...20mA sut charge maxi 500Ω, précision supérieure à 0.2 % p.e. Résolution 12 bits. Il est possible de configurer la sortie 0/2...10V par un cavalier qui insère un shunt de 500Ω en parallèle à la sortie, courant maxi de court-circuit 20mA. Précision en l'absence d'étalonnage supérieure à 1 % sur p.e. Pour obtenir une précision plus élevée, effectuer l'étalonnage utilisateur (sortie analogique), comme décrit dans le Manuel Opérateur.

Tipo di uscita	Jumper S1
20mA	OFF (aperto) standard
10V	ON (chiuso)

Type de sortie	Cavalier S1
20mA	OFF (ouvert) standard
10V	ON (fermé)

TECHNICAL DATA

Standard output 0/4...20mA on max. load 500Ω, accuracy better than 0.2 % f.s. Resolution 12 bit. The 0/2...10V output can be configured by jumper, which inserts a 500Ω shunt in parallel to the output, max. short circuit current 20mA. Accuracy in absence of calibration better than 1% f.s. If greater accuracy is required, perform the user calibration (analog output) as described in the instruction manual.

DATOS TÉCNICOS

Salida estándar 0/4...20mA en carga máx. 500Ω, precisión superior a 0,2 % f.s. Resolución 12 bits. Es posible configurar la salida 0/2...10 V mediante jumper que conecta un shunt de 500Ω en paralelo con la salida; corriente máx. de cortocircuito 20mA. Precisión sin calibración superior a 1 % sobre f.s. Si se desea obtener mayor precisión se deberá efectuar la calibración usuario (salida analógica), procediendo de la manera ilustrada en el manual de uso.

Output type	Jumper S1
20mA	OFF (open) standard
10V	ON (closed)

Tipo de salida	Jumper S1
20mA	OFF (abierto) estándar
10V	ON (cerrado)

TECHNISCHE DATEN

Standardausgang 0/4...20mA bei max. Last von 500Ω, Genauigkeit besser als 0,2 % v.Ew. Auflösung 12 Bit. Es ist möglich, den Ausgang 0/2...10V mittels Jumper zu konfigurieren, der einen Nebenwiderstand von 500Ω parallel zum Ausgang zwischenschaltet; max. Kurzschlussstrom 20mA. Genauigkeit ohne Kalibrierung besser als 1 % v.Ew. Wenn eine höhere Genauigkeit verlangt ist, die kundenspezifische Kalibrierung (Analogausgang) wie in der Bedienungsanleitung beschrieben vornehmen.

DADOS TÉCNICOS

Saída padrão 0/4...20mA sobre carga máxima de 500Ω, grau de precisão inferior a 0,2 % f.e. Resolução 12 bit. É possível configurar a saída 0/2...10V mediante ponte que introduz um shunt de 500Ω em paralelo na saída, corrente máx. de curto-circuito 20mA. O grau de precisão na ausência de calibração é inferior a 1 % do f.e. No caso de desejar maior precisão, faça a calibração do usuário (saída analógica) conforme descrito no manual de utilização.

Ausgangstyp	Jumper S1
20mA	OFF (Offen) Standard
10V	ON (Geschlossen)

Tipo de saída	Jumper S1
20mA	OFF (aberto) padrão
10V	ON (fechado)

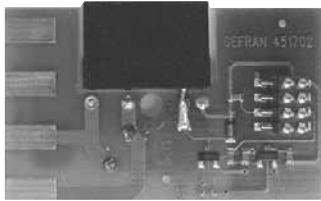

USCITA RELÉ (OUT4)
RELAY OUTPUT (OUT4)
RELAISAUSGANG (OUT4)
SORTIE RELAIS (OUT4)
SALIDA RELÉ (OUT4)
SAÍDA DE RELÉ (OUT4)

PROFILO

Questa scheda supporta la funzione di uscita prevista come OUT4 nello strumento 40T48. Adatta a pilotare carichi resistivi sino ad un massimo di 5A a 250Vac / 30Vdc. La schedina è automaticamente riconosciuta dallo strumento che abilita visibilità ed impostazione dei parametri relativi.

PROFILE

This board supports the output function provided as OUT4 on the 40T48 instrument. Suitable for piloting resistive loads up to a maximum of 5A at 250V AC/30Vdc. The board is automatically recognized by the instrument, which enables display and setting of the parameters involved.

BESCHREIBUNG

Diese Karte unterstützt die als OUT4 beim Instrument 40T48 vorgesehene Ausgangsfunktion Sie eignet sich zum Steuern von ohmschen Lasten bis maximal 5A bei 250Vac/30Vdc. Das Gerät erkennt die Karte automatisch und aktiviert die Funktionen für die Anzeige und die Einstellung der entsprechenden Parameter.

GENERALITES

Cette carte supporte la fonction sortie prévue comme OUT4 dans l'outil 40T48. Elle est apte à piloter des charges résistives jusqu'à un maximum de 5A à 250Vca/30Vcc. La carte est automatiquement reconnue par l'outil qui habilite la visibilité et la programmation des paramètres appropriés.

PERFIL

Esta ficha soporta la función de salida prevista como OUT4 en el instrumento 40T48. Idónea para pilotar las cargas resistivas hasta un máximo de 5 A a 250 Vca/30 Vcc. La ficha es reconocida de modo automático por el instrumento, que habilita visibilidad y programación de los respectivos parámetros

PERFIL

Esta placa suporta a função de saída prevista como OUT4 no instrumento 40T48. É indicada para pilotar cargas resistivas até um máximo de 5A a 250Vca/30Vcc. A placa é reconhecida automaticamente pelo instrumento, que habilita a visibilidade e configuração dos respectivos parâmetros.

DATI TECNICI

Relè a singolo contatto NO
 Corrente max 5A a 250Vac / 30Vdc $\cos\varphi = 1$
 Protezione MOV 275V 0.25W in parallelo al contatto
 È possibile ottenere il relè eccitato all'accensione tramite l'esecuzione del ponticello S1 e la rimozione della resistenza R4.

CARACTERISTIQUES TECHNIQUES

Relais à contact simple NO
 Courant maxi 5A à 250Vca / 30Vcc $\cos\varphi = 1$
 Protection MOV 275V 0,25W en parallèle au contact
 Il est possible d'obtenir le relais excité lors de la mise sous tension en exécutant le cavalier S1 et en retirant la résistance R4.

TECHNICAL DATA

Single-contact relay NO
 Max. current 5A at 250Vac / 30Vdc $\cos\varphi = 1$
 Protection MOV 275V 0.25W in parallel to contact
 The relay can be energized at power-up by installing jumper S1 and removing resistance R4.

DATOS TÉCNICOS

Relè a singolo contatto NO
 Relé de contacto único NA
 Corriente máx. 5A a 250Vca / 30Vcc $\cos\varphi = 1$
 Protección MOV 275V 0,25W en paralelo con contacto
 Es posible obtener la excitación del relé con el encendido mediante aplicación del puente S1 y remoción de la resistencia R4.

TECHNISCHE DATEN

Relais mit einem Schließer
 Max. Strom 5A bei 250Vac / 30Vdc $\cos\varphi = 1$
 MOV-Schutz 275V 0,25W parallel zum Kontakt
 Die Erregung des Relais bei der Einschaltung ist möglich, wenn man die Brücke S1 herstellt und den Widerstand R4 entfernt.

DADOS TÉCNICOS

Relé com contacto único NA
 Corrente máx. 5A a 250Vca / 30Vcc $\cos\varphi = 1$
 Proteção MOV 275V ,25W em paralelo no contato
 É possível ter o relé excitado no momento de ligação, construindo a ponte S1 e removendo a resistência R4.

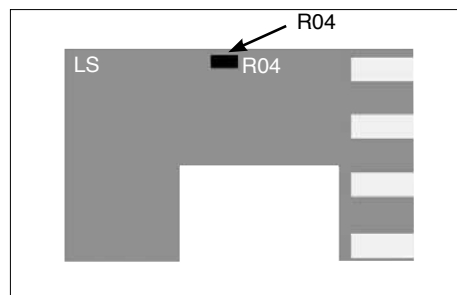
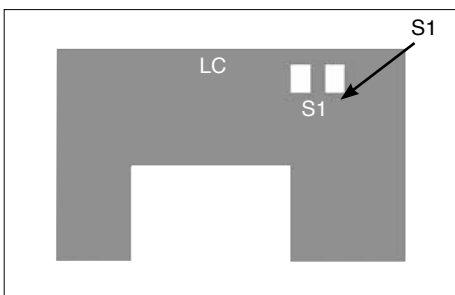

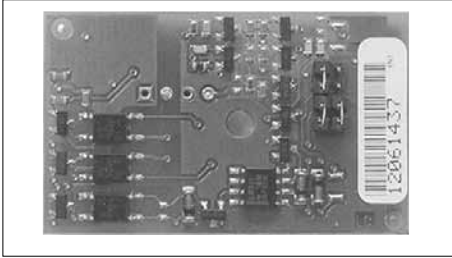

USCITA SERIALE (OUT4)
SERIAL OUTPUT (OUT4)
SERIELLER AUSGANG (OUT4)
SORTIE SERIE (OUT4)
SALIDA SERIE (OUT4)
SAÍDA SERIAL (OUT4)

PROFILO

Questa scheda supporta la funzione di uscita prevista come OUT4 nello strumento 40T48. Interfaccia seriale standard RS485. La scheda è automaticamente riconosciuta dallo strumento che abilita visibilità ed impostazione dei parametri relativi.

PROFILE

This board supports the output function provided as OUT4 on the 40T48 instrument. RS485 standard serial interface. The board is automatically recognized by the instrument, which enables display and setting of the parameters involved.

BESCHREIBUNG

Diese Karte unterstützt die als OUT4 beim Instrument 40T48 vorgesehene Ausgangsfunktion. Serielle Standardschnittstelle RS485. Das Gerät erkennt die Karte automatisch und aktiviert die Funktionen für die Anzeige und die Einstellung der entsprechenden Parameter.

GENERALITES

Cette carte supporte la fonction sortie prévue comme OUT4 dans l'outil 40T48. Interface série standard RS485. La carte est automatiquement reconnue par l'outil qui habilite la visibilité et la programmation des paramètres appropriés.

PERFIL

Esta ficha soporta la función de salida prevista como OUT4 en el instrumento 40T48. Interfaz serie estándar RS485. La ficha es reconocida de modo automático por el instrumento, que habilita visibilidad y programación de los respectivos parámetros.

PERFIL

Esta placa suporta a função de saída prevista como OUT4 no instrumento 40T48. Interface serial padrão RS485. A placa é reconhecida automaticamente pelo instrumento, que habilita a visibilidade e configuração dos respectivos parâmetros.

DATI TECNICI

Standard RS485. Isolamento 1500V. Baudrate 19200 max
Collegamento 2 o 4 fili per protocollo MODBUS o CENCAL
Tramite jumper è possibile effettuare il collegamento parallelo tra Tx ed Rx nel caso di collegamento 2 fili con protocollo MODBUS.

CARACTERISTIQUES TECHNIQUES

Standard RS485. Isolement 1500V. Baudrate 19200 maxi
Connexion 2 ou 4 fils pour protocoles MODBUS ou CENCAL
Par le biais d'un cavalier, il est possible d'effectuer la connexion parallèle entre Tx et Rx en cas de connexion 2 fils avec protocole MODBUS.

TECHNICAL DATA

Standard RS485. Isolation 1500V. Baudrate 19200 max
2 or 4 wire connection for MODBUS or CENCAL protocol.
A parallel connection between Tx and Rx can be made in the case of 2-wire connection with MODBUS protocol.

DATOS TÉCNICOS

Estándar RS485. Isolamiento 1500V. Baudrate 19200 máx.
Conexión 2 ó 4 hilos para protocolo MODBUS o CENCAL
Mediante jumper es posible efectuar la conexión paralela entre tra Tx y Rx en caso de conexión 2 hilos con protocolo MODBUS.

TECHNISCHE DATEN

Standard RS485. Isolationsspannung 1500V. Baudrate 19200 max. Anschluss 2- oder 4-Leiter für Protokoll MODBUS oder CENCAL. Mit einem Jumper ist der parallele Anschluss zwischen Tx und Rx bei 2-Leiter-Anschluss für Protokoll MODBUS möglich.

DADOS TÉCNICOS

Padrão RS485. Isolamento 1500V. Baudrate 19200 máx.
Ligação de 2 ou 4 fios para protocolo MODBUS ou CENCAL
Mediante jumper é possível fazer a ligação de Tx e Rx em paralelo em caso de ligação 2 fios com protocolo MODBUS.

MODBUS



CENCAL

